

Camera Manual

# Q26 Hemispheric



20.033.106-01\_EN\_05/2019

## THE MOBOTIX INFORMATION CHANNELS

**MOBOTIX**  
BeyondHumanVision

Support on the MOBOTIX Website  
[www.mobotix.com/en/support](http://www.mobotix.com/en/support)



The MOBOTIX Video Tutorials  
[www.mobotix.com/en/support/download-center/documentation/video-tutorials](http://www.mobotix.com/en/support/download-center/documentation/video-tutorials)



Seminars on MOBOTIX Campus  
[www.mobotix.com/en/support/trainings](http://www.mobotix.com/en/support/trainings)



The MOBOTIX YouTube Channel  
[www.youtube.com/user/MobotixAG](http://www.youtube.com/user/MobotixAG)



### MOBOTIX Seminars

MOBOTIX offers inexpensive seminars that include workshops and practical exercises. For more information, visit [www.mobotix.com](http://www.mobotix.com) > **Support** > **Trainings**.

### Copyright Information

**All rights reserved.** *MOBOTIX*, the MX logo, *MxManagementCenter* and *MxPEG* are trademarks of MOBOTIX AG registered in the European Union, the U.S.A., and other countries. *Microsoft*, *Windows* and *Windows Server* are registered trademarks of Microsoft Corporation. *Apple*, the Apple logo, *Macintosh*, *OS X*, *iOS*, *Bonjour*, the Bonjour logo, the Bonjour icon, *iPod* and *iTunes* are trademarks of Apple Inc. registered in the U.S.A. and other countries. *iPhone*, *iPad*, *iPad mini* and *iPod touch* are Apple Inc. trademarks. *Linux* is a trademark of Linus Torvalds. All other marks and names mentioned herein are trademarks or registered trademarks of the respective owners.

Copyright © 1999-2019, MOBOTIX AG, Langmeil, Germany. Technical information subject to change without notice. MOBOTIX AG and its subsidiaries do not assume any liability for technical or editorial errors or omissions contained herein.

Download the latest version of this and other manuals as PDF files from [www.mobotix.com](http://www.mobotix.com) > **Support** > **Download Center** > **Documentation** > **Manuals**.

## TABLE OF CONTENTS

<b>Legal Notes</b>	<b>6</b>
<b>Safety Warnings</b>	<b>7</b>
<b>Foreword</b>	<b>8</b>
<b>1 Product Overview</b>	<b>10</b>
1.1 Lenses, Hardware, Image Formats	10
1.2 Software Features	11
1.3 Technical Data	12
1.4 Delivered Parts and Dimensions	14
1.4.1 The Q26 Camera	14
1.4.2 Mounting Kits and Mounts	17
1.5 Available Accessories	25
1.5.1 On-Wall Set	25
1.5.2 10° On-Wall Set	25
1.5.3 Vandalism Set	25
1.5.4 In-Ceiling Set	26
1.5.5 Outdoor Wall Mount	26
1.5.6 Corner and Pole Mount	26
1.5.7 Stand/Wall Mount for Camera Tests	26
1.5.8 MiniUSB Cable to MiniUSB (Angled/Straight)	27
1.5.9 MiniUSB Cable to MiniUSB (Angled/Angled)	27
1.5.10 MiniUSB Cable to USB-A Socket	27
1.5.11 Ethernet Patch Cable for Bayonet Catch	27
1.5.12 NPA-PoE-Set	28
1.5.13 MX-Overvoltage-Protection-Box	28
1.5.14 MX-NPA-Box	28
1.5.15 MX-GPS-Box	29
1.5.16 MX-232-IO-Box	29
1.5.17 ExtIO Expansion Module	29
1.5.18 Mx2wire+ Media Converter	30
1.5.19 Other Accessories	30
1.6 MOBOTIX Software	31
1.6.1 Integrated Camera Software (Firmware)	31
1.6.2 MxManagementCenter	32
1.6.3 MOBOTIX MxBell	33

<b>2</b>	<b>Installation</b>	<b>34</b>
<b>2.1</b>	<b>Preparing the Installation</b>	<b>34</b>
2.1.1	Wall-Mounted	35
2.1.2	Ceiling-Mounted	38
2.1.3	Mounting Options	41
2.1.4	Network Connection And Power Supply, UPS	44
2.1.5	Preparing the Camera Connections, MX-Overvoltage-Protection-Box	45
2.1.6	Wiring, Fire Prevention, Lightning and Surge Protection	46
<b>2.2</b>	<b>Mounting the Camera Without Accessories</b>	<b>48</b>
2.2.1	Mounting Instructions	48
2.2.2	Procedure	50
<b>2.3</b>	<b>Mounting the Camera with the On-Wall Set</b>	<b>54</b>
2.3.1	Mounting Instructions	54
2.3.2	Procedure	57
<b>2.4</b>	<b>Mounting the Camera with the In-Ceiling Set</b>	<b>59</b>
2.4.1	Mounting Instructions	59
2.4.2	Procedure	62
<b>2.5</b>	<b>Installing the Vandalism Set</b>	<b>64</b>
2.5.1	Mounting Instructions	64
2.5.2	Procedure	65
<b>2.6</b>	<b>Installing the Wall Mount</b>	<b>67</b>
2.6.1	Mounting Instructions	67
2.6.2	Procedure	70
<b>2.7</b>	<b>Installing the Corner and Pole Mount</b>	<b>72</b>
2.7.1	Mounting Instructions	72
2.7.2	Mounting to a Pole	74
2.7.3	Mounting to a Wall or Building Corner	75
2.7.4	Mounting the Wall Mount to the Corner and Pole Mount	76
<b>2.8</b>	<b>Replacing the MicroSD Card</b>	<b>77</b>
2.8.1	Removing the MicroSD Card	77
2.8.2	Inserting a MicroSD Card	78
<b>2.9</b>	<b>Network and Power Connection, Additional Cables</b>	<b>79</b>
2.9.1	Notes on Cable Lengths and Power Supply	79
2.9.2	Connecting the Q26 to the Network Using a Patch Cable	79
2.9.3	Power Supply Using a Switch	80
2.9.4	Power Supply When Connected Directly to a Computer	81
2.9.5	Power Supply with Power-Over-Ethernet Products	81
2.9.6	Connecting a USB Cable	82
2.9.7	Connecting a Two-Wire MxBus Cable	83
2.9.8	Variable PoE	84

# Table of Contents

---

<b>3</b>	<b>Operating the Camera</b>	<b>86</b>
<b>3.1</b>	<b>Manual and Automatic Operation – Overview</b>	<b>86</b>
<b>3.2</b>	<b>First Images and the Most Important Settings</b>	<b>88</b>
3.2.1	Manually Setting Up the Network Parameters in a Browser	88
3.2.2	First Images and the Most Important Settings in the Browser	91
3.2.3	First Images and Network Parameter Configuration in MxMC	93
3.2.4	Boot Options of the Camera	96
<b>3.3</b>	<b>Virtual PTZ and Full Image Recording</b>	<b>98</b>
3.3.1	Preparing the Virtual PTZ Function	98
3.3.2	Full Image Recording	100
3.3.3	Special Q26 Configuration in the Browser	102
<b>3.4</b>	<b>MicroSD Card Recording</b>	<b>109</b>
3.4.1	Introduction	109
3.4.2	Formatting the MicroSD Card	111
3.4.3	Activating MicroSD Card Recording	112
3.4.4	Accessing Data on the MicroSD Card	113
3.4.5	Deactivating Card Recording	113
3.4.6	Using a MicroSD Card in a Different MOBOTIX Camera	114
3.4.7	Limitations on Warranty When Using Flash Storage Media	114
<b>3.5</b>	<b>Configuration in the Browser</b>	<b>115</b>
3.5.1	Overview	115
3.5.2	General Browser Settings	117
<b>3.6</b>	<b>Additional Notes</b>	<b>119</b>
3.6.1	Weatherproofness	119
3.6.2	Password for the Admin Menu	119
3.6.3	Permanently Deactivating the Microphone	119
3.6.4	Using the Boot Options of the Camera	120
3.6.5	Activating Event Control and Motion Detection	120
3.6.6	Deactivating Text and Logo Options	120
3.6.7	Deactivating the Camera Reboot	120
3.6.8	Browser	121
3.6.9	Cleaning the Camera and Lens	121
3.6.10	Legal Notes	121
3.6.11	Safety Warnings	121
3.6.12	Online Help in the Browser	122
3.6.13	Declaration of Conformity	122
3.6.14	RoHS Declaration	123
3.6.15	Disposal	123
3.6.16	Disclaimer	123

### **LEGAL NOTES**

#### **Legal aspects of video and sound recording**

You must comply with all data protection regulations for video and sound monitoring when using MOBOTIX products. Depending on national laws and the installation location of the Q26, the recording of video and sound data may be subject to special documentation or it may be prohibited. All users of MOBOTIX products are therefore required to familiarize themselves with all applicable regulations and to comply with these laws. MOBOTIX AG is not liable for any illegal use of its products.

---

## SAFETY WARNINGS

### Notes on Installing:

- This product must not be used in locations exposed to the dangers of explosion.
- Make sure that you install this product as outlined in Chapter 2, «Installation» of this manual. A faulty installation can damage the camera!
- When installing this product, make sure that you are only using genuine MOBOTIX parts and MOBOTIX connection cables.
- Only install this product on suitable, solid materials that provide for a sturdy installation of the fixing elements used.



**Electrical installation:** Electrical systems and equipment may only be installed, modified and maintained by a qualified electrician or under the direction and supervision of a qualified electrician in accordance with the applicable electrical guidelines. Make sure to properly set up all electrical connections.



**Electrical surges:** MOBOTIX cameras are protected against the effects of small electrical surges by numerous measures. These measures, however, cannot prevent the camera from being damaged when stronger electrical surges occur. Special care should be taken when installing the camera outside of buildings to ensure proper protection against **lightning**, since this also protects the building and the whole network infrastructure.



**Max. power consumption of attached extension modules:** The power consumption of all attached **MxBus modules** must **not exceed 2.5W**. When attaching modules to the MxBus connector **and** the USB socket, the **power consumption of all attached modules must not exceed 3W, if the camera is powered by PoE class 3**. If **PoE class 2** is used, **the camera cannot power any peripheral devices!**



**Never touch the lens:** Due to the high performance of the Q26, the area of the image sensor can get quite hot, especially when the ambient temperature is also high. This does not affect the proper functioning of the camera in any way. For this reason, the product must not be installed within the reach of persons.



**Power off before opening the camera:** Make sure the power supply to the camera is disconnected before opening the camera housing (e.g., when inserting or exchanging lenses, lens units and SD cards).



**Network security:** MOBOTIX products include all of the necessary configuration options for operation in Ethernet networks in compliance with data protection laws. The operator is responsible for the data protection concept across the entire system. The basic settings required to prevent misuse can be configured in the software and are password-protected. This prevents unauthorized parties from accessing these settings.



### FOREWORD

Dear MOBOTIX customer,

Congratulations on your decision to purchase a professional and modern HiRes network camera “Made in Germany”! The Q26 provides 360-degree overview with only one hemispherical lens. This means that you only need one camera to monitor the entire room right into all four corners. The fisheye distortion that is typical for this kind of lens is automatically corrected by the camera software in the live image. Add to that the proven advantages that are inherent to the MOBOTIX concept, such as the integrated event, alarm and telephone features and the modern long-term storage directly in the camera with all of its benefits.



The weatherproof MxBus and MiniUSB interfaces of the camera allow attaching MOBOTIX interface boxes and standard devices, such as 3G/UMTS modems, external storage devices, etc. The pre-installed MicroSD card flash storage is easily exchanged for larger storage requirements, providing for secure long-term storage.

The introduction of the newest image sensor technology with increased light sensitivity provides brilliant images with image sizes of up to 3072x2048 pixels, thus delivering color images of higher quality under lowlight conditions.

You can download the **MxManagementCenter** video management software for MOBOTIX cameras from the MOBOTIX website: [www.mobotix.com](http://www.mobotix.com) > **Support** > **Download Center** > **Software Downloads**. The tutorial for the application is available from **Support** > **Download Center** > **Documentation** > **Brochures & Guides** > **Tutorials**.

For iPad, iPhone, and Android devices, MOBOTIX offers the **MOBOTIX MxBell**, a free-of-charge mobile solution that is easily found when searching for “MOBOTIX AG” in the App Store or on Google Play.

If you have any questions, our support and international sales staff are available at [intl-support@mobotix.com](mailto:intl-support@mobotix.com) from Monday to Friday, 8 am to 6 pm (German time).

We would like to thank you for your trust and wish you all the best with your new MOBOTIX camera Q26 Hemispheric!

# MOBOTIX

BeyondHumanVision

BEYOND HUMAN VISION

MOBOTIX





## 1 PRODUCT OVERVIEW

### 1.1 Lenses, Hardware, Image Formats

<b>Lenses, Sensors</b>	
B016 Hemispheric	•
B036* Super Wide-Angle	–
B041* Super Wide-Angle	–
B061 Wide-Angle	–
B079 Wide-Angle	–
B119 Tele	–
B237 Tele	–
B500 Tele	–
CSVario 4.5 to 10 mm	–
Image sensor with individual exposure zones	Color/BW
Sensor sensitivity 6MP in lux at 1/60 s and 1 s	0.1 / 0.005 (Color) 0.02 / 0.001 (BW)
<b>Hardware Features</b>	
IP protection class	IP65
Temp. Internal DVR (MB)	64
Internal DVR (MicroSD, SDXC, pre-installed)	•
Microphone/speaker	•/•
Passive infrared sensor (PIR)	–
Integrated temperature sensor	•
Shock detector	•
Power consumption in Watts (typical)	< 4W
Variable PoE class	2 – 3
<b>Image Formats, Frame Rates and Image Storage</b>	
Max. resolution (per sensor)	6MP (3072x2048)
Max. frame rate (MxPEG, max. resolution)	6MP: 12 fps
CIF images with 4 GB MicroSD DVR	250,000
VGA images with 4 GB MicroSD DVR	125,000
MEGA images with 4 GB MicroSD DVR	40,000
QXGA images with 4 GB MicroSD DVR	20,000

## 1.2 Software Features

General Features	
Digital zoom (continuous) with panning	•
Motion JPEG/MxPEG/H.264 codecs	•/•/–
Programmable exposure ones	•
Snapshot rec. (pre-/post-alarm images)	50
Terabyte ring buffer storage (internal/network)	•
Event/continuous rec. with sound (0.2 to 30 fps)	•/•
Time and event control	•
Weekly schedules/holidays	•
Web functionality (FTP, email)	•
Playback/Quad- und MultiView	•
Bidirectional sound in browser	•
Logo generator, animated	•
Flexible event logic	•
Master/Slave arming	•
Several scheduled privacy zones	•
Customized voice messages	•
VoIP telephony (audio/video, alert)	•
Remote alarm notification (network msg.)	•
Signal inputs/outputs, RS232	Via MX-Input-Box/MX-Output-Box or MX-232-IO-Box
Programming interface/HTTP API	•
Security features (HTTPS/SSL, IP-based access control, IEEE 802.1X network authentication)	•
Video Analysis	
Video Motion detector	•
MxAnalytics	•
MxActivitySensor	•
Video Management Software	
MxManagementCenter	•
MOBOTIX MxBell	•

Free-of-charge download from [www.mobotix.com](http://www.mobotix.com) or App Store/Google Play

### 1.3 Technical Data

<b>Model Variants</b>	Mx-Q26A/B*-6D016 (daylight image sensor, color) Mx-Q26A/B*-6N016 (night image sensor, Black&White) *Variant Mx-Q26B supports MOBOTIX MxBus modules
<b>Lens Option</b>	B016 (focal length 1.6 mm, f/2.0, image angle 180°x180°)
<b>Sensitivity</b>	Color sensor (daylight): 0,1 lx @ 1/60s; 0,005 lx @ 1s Black&White sensor (night): 0,02 lx @ 1/60s; 0,001 lx @ 1s
<b>Image Sensor</b>	1/1.8" CMOS, 6MP (3072x2048), Progressive Scan
<b>Max. Image Size</b>	6MP (3072x2048)
<b>Image Formats</b>	Freely configurable 4:3, 8:3, 16:9 or custom formats (image cropping), e.g., 2592x1944 (5MP), 2048x1536 (QXGA), 1920x1080 (Full-HD), 1280x960 (MEGA)
<b>Max. Frame Rate</b>	MxPEG: 42@HD(1280x720), 34@Full-HD, 24@QXGA, 15@5Mp, 12@6MP M-JPEG: 26@HD(1280x720), 13@Full-HD, 9@QXGA, 5@5Mp, 4@6MP H.264: 25@Full-HD, 20@QXGA
<b>Video Codec</b>	MxPEG, M-JPEG, JPEG (max. output size 6MP) H.264 (max. output size QXGA, bandwidth limitation applicable)
<b>ONVIF</b>	ONVIF S (camera software V5.2.x and higher)
<b>DVR</b>	In the camera on MicroSD card (SDXC, SDHC pre-installed) <ul style="list-style-type: none"> <li>External, on USB device</li> <li>External, on NAS</li> <li>Separate live image and full image recording – MxFFS with archiving function</li> <li>Pre- and post-alarm images</li> <li>Automatic DVR monitoring with error notification</li> </ul>
<b>Software</b>	MxManagementCenter, MOBOTIX MxBell
<b>Image Processing</b>	MxLEO, backlight compensation, automatic white balance, distortion correction
<b>PTZ</b>	Digital pan/tilt/zoom, continuous up to 8X
<b>Alarm/Events</b>	Temperature sensor, shock detector (with firmware version 5.0.1 and higher), microphone, additional sensors/IOs via MxMessageSystem, notification via e-mail, FTP, IP telephony (VoIP, SIP), visual/sound alarms, pre- and post-alarm images
<b>Intelligent Video Analysis</b>	MxActivitySensor, video motion analysis, MxAnalytics
<b>Audio</b>	Microphone/speaker, both 16bit/16kHz (HD wideband audio) Lip-synchronous audio, audio recording VoIP/SIP telephony, intercom, remote controlling using key codes
<b>Interfaces</b>	Ethernet 100Base-T, MiniUSB, MxBus*; inputs/outputs and RS232 via accessories *Only variant Mx-Q26B
<b>Security</b>	User/group management, HTTPS/SSL, IP address filter, IEEE 802.1x, intrusion detection, digital image signature, MxFFS

<b>Certifications</b>	EN 55032:2012, EN 55024:2010, EN 50121-4:2015, FprEN 61000-6-1:2015, EN 61000-6-2:2015, EN 61000-6-3:2007+A1:2011+AC:2012, EN 61000-6-4:2007+A1:2011, EN 50581:2012, EN 60950-1:2006+A11:2009+A1:2010+A12:2011+A2:2013, E13*10R05/01*14648*00, 47 CFR Part 15B, AS/NZS CISPR32:2015
<b>Power Supply</b>	Power over Ethernet IEEE 802.3af
<b>Power Consumption</b>	Typ. 4 W
<b>Power Consumption of External Devices</b>	At MxBus: max. 2.5 W, at USB: max. 2.5 W, total max. 3 W The power consumption of the camera will increase accordingly!
<b>Protection Classes</b>	IP65 IK06, IK10 with Vandalism Set
<b>Ambient Temperature</b>	-30 to 50 °C/-22 to 122 °F
<b>Dimensions/Weight</b>	Diameter x height: 160 x 48 mm/6.30 x 1.89 in; weight: approx. 350 g
<b>Standard Delivery</b>	Housing (high-resistance composite, PBT) white, mounting supplies, mounting wrenches, 50 cm/20 in patch cable, software, MicroSD card (SDXC, SDHC installed)



## 1.4 Delivered Parts and Dimensions

### 1.4.1 The Q26 Camera



Item	Quantity	Part Name
1.1	1	Camera housing
1.2	1	Lens (installed)
1.3	1	Lens wrench
1.4	1	microSD card (SDXC, SDHC pre-installed)
1.5	1	Ethernet patch cable CAT5 0.5 m/20 in, installed
1.6	1	Allen wrench 3 mm
1.7	1	Allen wrench 2 mm
1.8	1	Torx wrench TX20
1.9	1	Outer shell
1.10	4	Mounting ring
1.11	4	Stainless steel washers 5.3 mm dia.
1.12	4	Dowels 8 mm
1.13	4	Stainless steel Torx screws 4.5x60 mm
1.14	4	Stainless steel washers 4.3 mm dia.
1.15	1	Stainless steel Allen screws M4x16 mm
1.16	2	Cable lock with bayonet catch (Ethernet patch cable, MiniUSB)

## Delivered Parts and Dimensions

---

### Camera Housing and Connectors

The MOBOTIX Q26 consists of the camera housing (motherboard and lens), the outer shell and the mounting ring.

### Connections

- NET (Ethernet network incl. PoE power supply)
- MiniUSB (e.g. for ExtIO)
- MxBus (only variant Mx-Q26B)
- Slot for MicroSD card

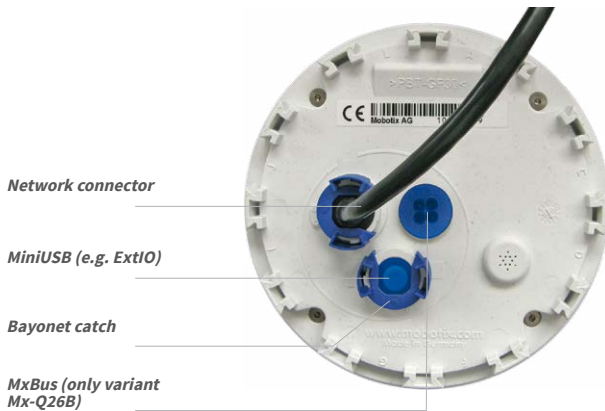
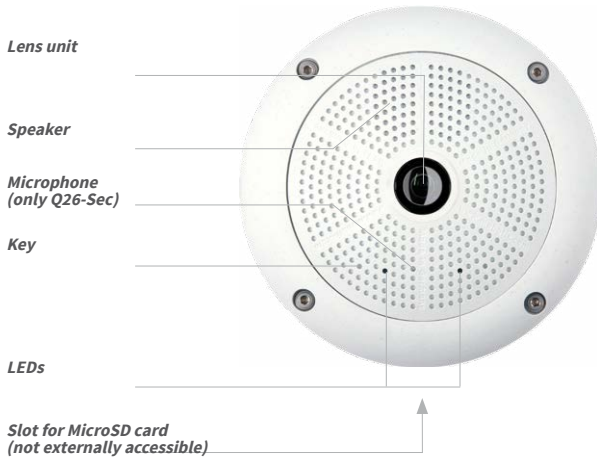

Q26: Dimensions Without Mounting Options

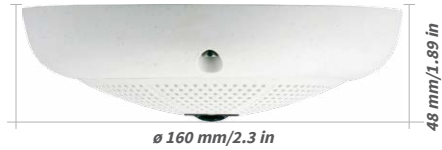

Mounting Ring Drilling Template (Incl. Space For Wall Outlet)

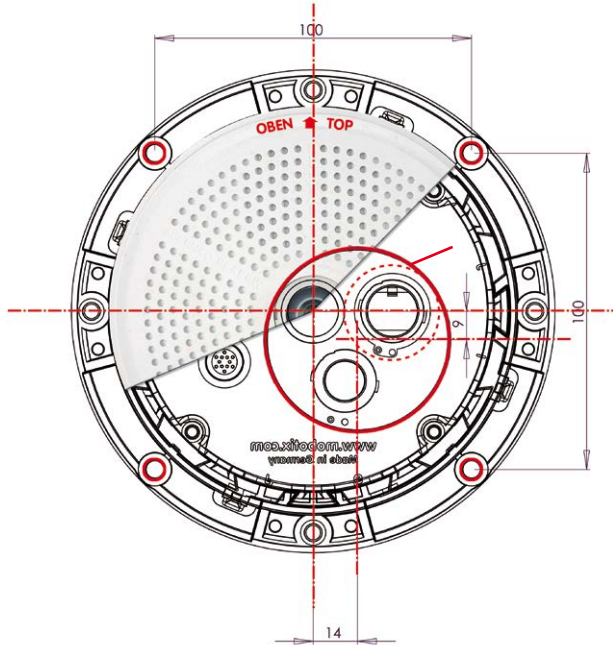

Note

You can download the drilling template from [www.mobotix.com](http://www.mobotix.com), Support > Download Center > Documentation > Drilling Templates.

Make sure that the drilling template is not scaled or adjusted to the paper size when printing the PDF file (enlarged or reduced).



## Delivered Parts and Dimensions

### 1.4.2 Mounting Kits and Mounts

#### On-Wall Set



The On-Wall Set must be ordered separately from the MOBOTIX camera.

Item	Quantity	Part Name
2.1	1	On-Wall set housing
2.2	4	Stainless steel Allen screws M4x35 mm
2.3	4	Stainless steel washers Ø4.3 mm
2.4	4	Foam rubber washers
2.5	4	Lock screws with counter nuts
2.6	2	Cable fitting with counter nut and O-ring cord

Drilling Template On-Wall Set

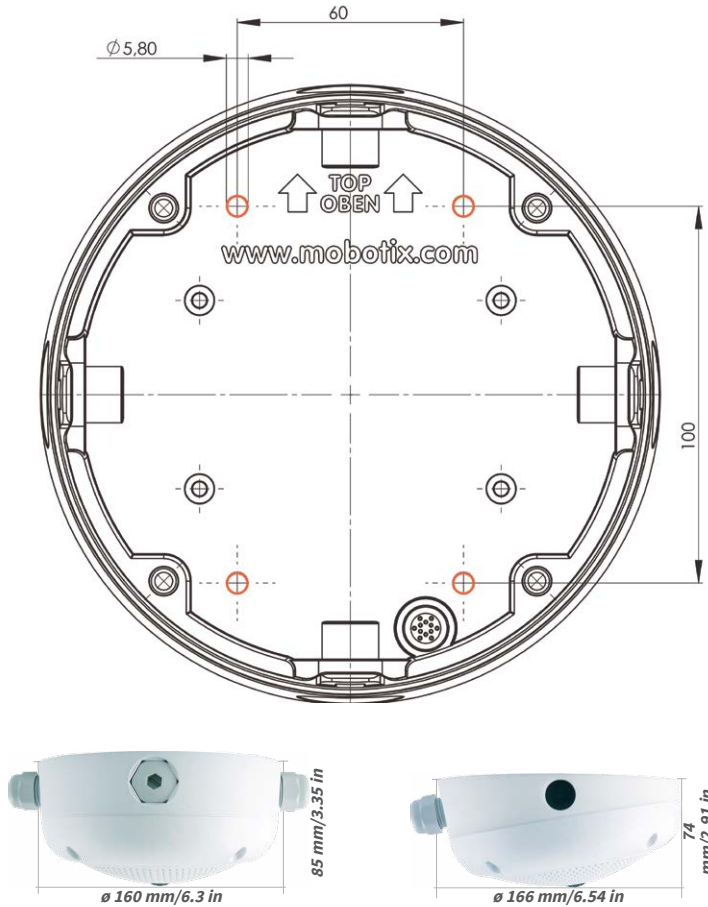

Notes

You can download the drilling template from [www.mobotix.com](http://www.mobotix.com), Support > Download Center > Documentation > Drilling Templates (applies to both 0° and 10° On-Wall Set).

Make sure that the drilling template is not scaled or adjusted to the paper size when printing the PDF file (enlarged or reduced).

The maximum torque for all screws is 1 to 1.2 Nm.

## Delivered Parts and Dimensions

### In-Ceiling Set



The In-Ceiling Set must be ordered separately from the MOBOTIX camera.

Item	Quantity	Part Name
3.1	1	Ceiling mounting ring incl. 4 flat headed screws
3.2	1	Decoration ring
3.3	2	Wrench for In-Ceiling mount
3.4	4	Clamps

Drilling Template In-Ceiling Set

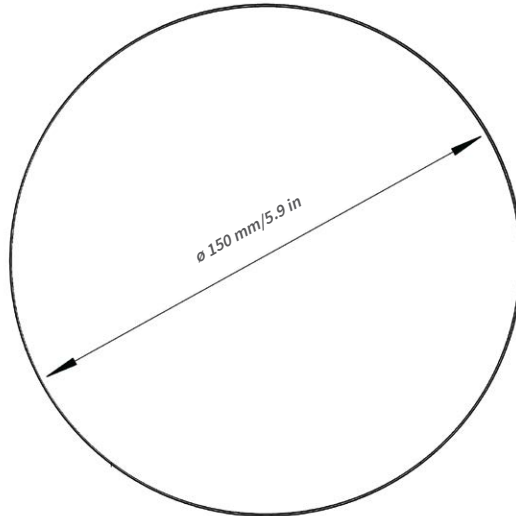

The In-Ceiling Set can be used in panels ranging from 6 to 22 mm/0.24 to 0.86 in thickness



**Notes**

You can download the drilling template from [www.mobotix.com](http://www.mobotix.com), Support > Download Center > Documentation > Drilling Templates.

Make sure that the drilling template is not scaled or adjusted to the paper size when printing the PDF file (enlarged or reduced).

# Delivered Parts and Dimensions

## Vandalism Set



The Vandalism Set must be ordered separately from the camera.

Item	Quantity	Part Name
4.1	1	Stainless steel cover 2 mm stainless steel
4.2	4	Spacers for Vandalism set
4.3	4	Security screws M4x16 mm
4.4	1	Two-hole driver bit for security screws
4.5	1	Polycarbonate dome incl. washer
4.6	1	Lens wrench

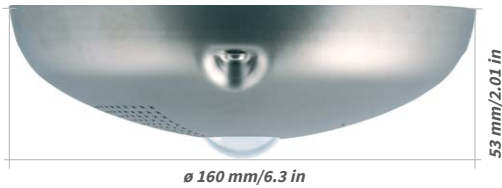

Wall Mount

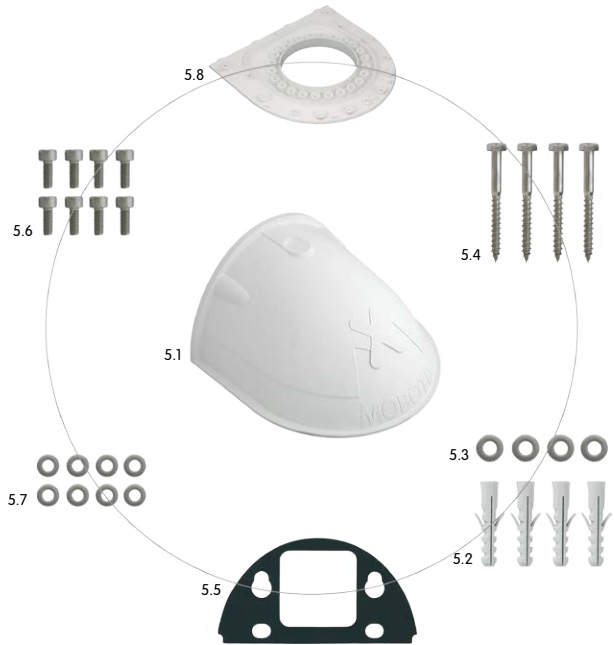

Item	Quantity	Part Name
5.1	1	Wall Mount
5.2	4	Universal screw anchors 8 mm
5.3	4	Stainless steel washers Ø 6.4 mm
5.4	4	Stainless steel wood screws with hex head 6x50 mm
5.5	1	Wall sealing
5.6	8	Stainless steel Allen screws M4x16 mm
5.7	8	Stainless steel washers Ø 4.3 mm
5.8	1	Bottom plate

### Drilling Template Wall Mount

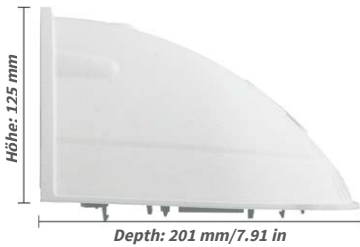
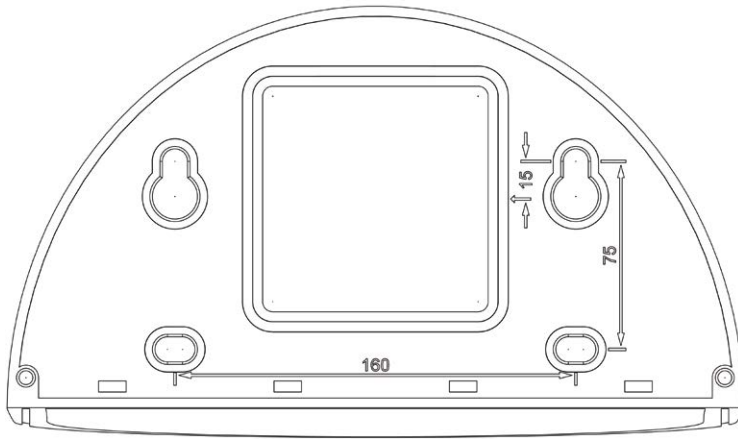

Direct installation over on-wall and flush-mounted wall outlets

#### Notes

You can download the drilling template from [www.mobotix.com](http://www.mobotix.com), Support > Download Center > Documentation > Drilling Templates.

Make sure that the drilling template is not scaled or adjusted to the paper size when printing the PDF file (enlarged or reduced).

Corner And Pole Mount

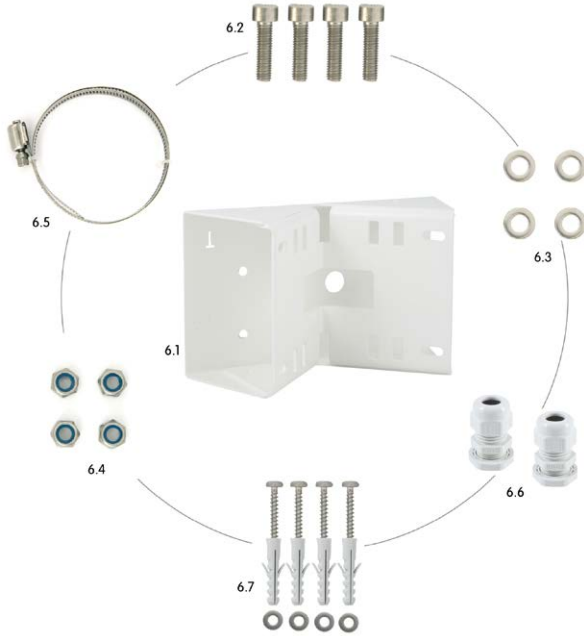

Item	Quantity	Part Name
6.1	1	Pole mount, stainless steel, white, powder-coated
6.2	4	Stainless steel Allen screws M6x20 mm
6.3	4	Stainless steel washers Ø 6 mm
6.4	4	Stainless steel lock nuts M6
6.5	2	Stainless steel straps
6.6	2	Cable fitting with counter nut and O-ring cord
6.7	4	Wood screws 6x80mm incl. screw anchors and washers

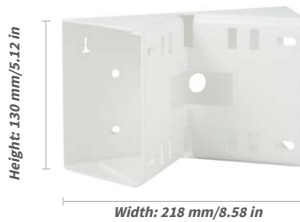



### 1.5 Available Accessories

#### 1.5.1 On-Wall Set

Order no.: MX-OPT-AP

Consists of On-Wall Mount and mounting supplies. Conforms to U.S. installation standards. Reliably protects the cabling and allows integrating additional modules within the On-Wall Mount (WLAN, battery, ...).



#### 1.5.2 10° On-Wall Set

Order no.: MX-OPT-AP-10DEG

Consists of On-Wall mount and mounting supplies for inclined installation (10°) of a camera. Conforms to U.S. installation standards. Reliably protects the cabling and allows integrating additional modules within the On-Wall Mount (WLAN, battery, ...).



#### 1.5.3 Vandalism Set

Order no.: MX-Q26-Sec-Vandal-ESMA

Design featuring matt stainless steel housing 1.5 mm strong. As above incl. lens protector and security screws.



### 1.5.4 In-Ceiling Set

**Order no.: MX-OPT-IC**

For simple installation in false ceiling tiles. Suitable for discreet surveillance. Optionally available with a stainless steel ring.



Can also be used as a wall mount in drywalls

### 1.5.5 Outdoor Wall Mount

**Order no.: MX-OPT-WH**

Consists of Outdoor Wall Mount and mounting supplies. Covers RJ45 wall outlets. Space for expansion modules (battery, UMTS, WLAN, etc.) Easily mounted to poles using Pole Mount. Weatherproof IP65.



### 1.5.6 Corner and Pole Mount

**Order no.: MX-OPT-MH**

Flange for Outdoor Wall Mount. Can be mounted to wall corners or poles. 3 mm stainless steel, white. Wall Mount may be ordered separately or as a set.



### 1.5.7 Stand/Wall Mount for Camera Tests

**Order no.: MX-OPT-TW-Demo-1**



The Stand/Wall Mount is a useful accessory for testing and for finding the optimum mounting position of the camera. The set also includes an Allen wrench as well as a Torx screw with dowel and the corresponding Torx wrench for installing as alternative wall mount for testing.

## Available Accessories

---

### Using as a Stand (with/without tripod)

Using this stand, you can now place the camera upright on a flat surface or mount the whole assembly on a tripod (1/4" tripod thread at the bottom of the stand).



### 1.5.8 MiniUSB Cable to MiniUSB (Angled/Straight)

Order no.: MX-CBL-MU-EN-STR-05/2/5 (angled/straight)

MOBOTIX add-on modules (MX-232-IO-Box, ExtIO, CamIO) can be connected directly to the Q26 with this cable, which is up to five meters long.



Only cables with angled plugs can be used for the Q26

### 1.5.9 MiniUSB Cable to MiniUSB (Angled/Angled)

Order no.: MX-CBL-MU-EN-EN-PG-05/2/5 (angled/angled)

The MOBOTIX ExtIO can be connected directly to the Q26 with this cable, which is up to five meters long.



### 1.5.10 MiniUSB Cable to USB-A Socket

Order no.: MX-CBL-MU-EN-AB-05/2/5

USB-based storage media (for example, USB hard drives) can be connected directly to the Q26 with this cable, which is up to five meters long.



### 1.5.11 Ethernet Patch Cable for Bayonet Catch

Order no.: MX-OPT-CBL-LAN-1/2/5/10 (length: 1 m/2 m/5 m/10 m)

The MOBOTIX-developed special cable can be installed in a waterproof manner and has an integrated sealing gasket. Every Q26 ships with a 0.5-m-long cable as standard, which can be exchanged for a patch cable up to 10 m in length.



### 1.5.12 NPA-PoE-Set

Order no.: MX-NPA-PoE-EU and MX-NPA-PoE-INT (Version EU and Version INT)

Order no.: MX-CBL-NPA-BAT-2 (battery cable for mobile voltage sources)

This is a multifunctional PoE injector according to the IEEE 802.3af standard – with three connectors (for network, camera/PoE device, PC), universal power supply unit with interchangeable adapter plugs and crossover function. The NPA-PoE-Set connects and remotely supplies a Q26 with power via an Ethernet cable up to 100 m in length. The blue adapter can also be connected to mobile voltage sources from 12 to 57 V DC by means of an additionally available battery cable. The “EU” version of the NPA-PoE-Set is supplied as standard with a European adapter, while the “INT” version includes four adapters (EU, USA, UK, AUS).



### 1.5.13 MX-Overvoltage-Protection-Box

Order no.: MX-Overvoltage-Protection-Box-RJ45

Order no.: MX-Overvoltage-Protection-Box-LSA

Weatherproof network connector (protection class IP65, -30 to 60 °C/-22 to 140 °F) **with surge protection of up to 4 kV for MOBOTIX IP cameras**, ideal for replacing the MX-Patch-Box.

At the same time, the MX-Overvoltage-Protection-Box provides a weatherproof connection of a camera's patch cable to a network patch cable (-**RJ45** variant) or a network installation cable (-**LSA** variant).



### 1.5.14 MX-NPA-Box

Order no.: MX-OPT-NPA1-EXT

The MX-NPA-Box is a weatherproof PoE injector conforming to the IEEE 802.3af standard and is designed to connect external voltage sources (12 to 57 V DC) to a MOBOTIX camera.

The MX-NPA-Box is equipped with the Patch-Box's weatherproof and extremely compact exterior housing (protection class IP65, -30 to 60 °C/-22 to 140 °F), which means it can also be installed in the space of the Outdoor Wall Mount. Interfaces of the MX-NPA-Box: Camera via patch cable, Ethernet via LSA+ and external power supply via terminal connector (12 to 57 V DC possible).

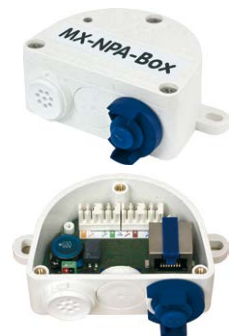

### 1.5.15 MX-GPS-Box

Order no.: MX-OPT-GPS1-EXT

The MX-GPS-Box primarily serves as a high-precision time source for systems without an Internet connection. In addition, it can provide triggering based on GPS events (reaching or moving away from a specified position; exceeding or not reaching a specified speed). This interface box can be attached to all MOBOTIX cameras with an MxBus interface.



The MX-GPS-Box is equipped with the same compact housing as the other interface boxes (protection class IP65, -30 to 60 °C/-22 to 140 °F). This interface box should not be installed inside of other wall mounts, but on the exterior of the building with a large section of open sky above it. This ensures the best possible reception from GPS satellites and thereby the highest possible accuracy of the received GPS data. The maximum length of the MxBus wiring (0.8 mm diameter wires) is 50 m/55 yd.

### 1.5.16 MX-232-IO-Box

Order no.: MX-OPT-RS1-EXT

This box provides the signal inputs and outputs as well as the RS232 (serial) interface. It replaces the connections that were handled on the older camera models via a D-Sub 15-HD connector. The MX-232-IO-Box (protection class IP65, -30 to 60 °C/-22 to 140 °F) can be attached to all MOBOTIX cameras with an MxBus or USB interface. The maximum length of the MxBus wiring (0.8 mm diameter wires) is 50 m/55 yd. If the MiniUSB connector is used, the maximum cable length is 5 m/16 ft.



### 1.5.17 ExtIO Expansion Module

Order no.: MX-ExtIO

The device, which is suitable both for on-wall and in-wall installations, contains a powerful speaker, microphone, infrared motion sensor, ambient temperature sensor, two input and two output contacts and two illuminated keys. It is ideal for door communication, elevators, access control systems, etc. The ExtIO is suitable for use as direct connection to the S15 via a MiniUSB cable (max. 5 m), which can be ordered separately, or as a network connection via the PoE switch.



### 1.5.18 Mx2wire+ Media Converter

Order no.: MX-2wirePlus-Set-PW

The Mx2wire+ system allows an Ethernet network with PoE to be set up via two-wire cables, which saves users from having to lay several hundred meters of Ethernet cable. For example, an existing two-wire cable of an analog video camera can be reused to connect a high-resolution and modern IP network camera. Mx2wire+ is delivered in the standard wall outlet frame in different designs; however, it can also be used with the available on-wall socket that is included.



### 1.5.19 Other Accessories

Since the range of accessories for the MOBOTIX system keeps growing, you should visit the MOBOTIX website [www.mobotix.com](http://www.mobotix.com) in the **Products > Accessories** section to see the entire list of available accessories.

## THE MOBOTIX INFORMATION CHANNELS

**MOBOTIX**

BeyondHumanVision

Support on the MOBOTIX Website  
[www.mobotix.com/en/support](http://www.mobotix.com/en/support)



The MOBOTIX Video Tutorials  
[www.mobotix.com/en/support/download-center/documentation/video-tutorials](http://www.mobotix.com/en/support/download-center/documentation/video-tutorials)



Seminars on MOBOTIX Campus  
[www.mobotix.com/en/support/trainings](http://www.mobotix.com/en/support/trainings)



The MOBOTIX YouTube Channel  
[www.youtube.com/user/MobotixAG](http://www.youtube.com/user/MobotixAG)







### 1.6.2 MxManagementCenter

MxManagementCenter (MxMC) is a completely new development that focuses on a unique and intuitive user experience. Single and double click, drag&drop, support of several screens and direct view of events and alarm messages are just some of the many advantages of the new software.

MxManagementCenter is perfectly designed in combination with MOBOTIX cameras representing the decentralized concept at its best. MxMC allows controlled recording access via the camera or later directly to the NAS.

A unique feature is the adaptive bandwidth management supporting quality search even over mobile networks with very limited bandwidth. MxMC is 100% free of charge, requiring no license or update costs and at the same time having no limits in terms of users, screens and cameras.

#### **MxManagementCenter – simple operation of the most important camera functions:**

- Integration of an unlimited number of cameras
- Camera groups with representation in Grid and Graphic views, Grid views with a focus window and many controls
- Optical and audible alarming of new events
- Instant Player that allows for quick viewing of the latest events during live video monitoring operation
- Easy use of multiple monitors by double-clicking on the live image, grid or event image
- Door station functions (intercom, open door, turn light on/off, etc.)
- Subsequent distortion correction of hemispheric camera images - in live images and in recordings

Download free of charge  
from [www.mobotix.com](http://www.mobotix.com)

No license fees!  
Free updates!





### 1.6.3 MOBOTIX MxBell

Never miss another visitor, thanks to push notifications! Use MOBOTIX MxBell on your smartphone or tablet to receive notifications from the doorbell of a MOBOTIX IP Video Door Station and live views from MOBOTIX cameras. This app helps you open the door and enables hands-free talking, automatic camera search, a live view, camera connection via SSL and display of the connection status.



#### Our new MOBOTIX MxBell is here!

The update scores with its new playback function, which makes it possible to search through the recorded events for the integrated Door Stations and cameras at a specific time point and play back the individual clips. In addition, the Grid view will simultaneously display up to four cameras, which in particular is a great advantage for small installations.

- Never miss another visitor, thanks to push notifications.
- Displays doorbell messages from MOBOTIX IP Video Door Stations.
- Live views from MOBOTIX IP cameras with gesture-controlled PTZ function.
- Open the door from anywhere, hands-free talking.
- Automatic camera search, live view and camera connection using SSL.
- Displays the connection status.
- Supports remote connections and mobile data.
- iOS 11/Android 5.0 and higher



Free download from [App Store](#)/[Google Play](#)

No license fees!  
Free updates!

## 2 INSTALLATION

The Q26 is primarily designed for installation on walls or ceilings. The supplied B016 180° lens captures the entire room, practically from wall to wall and from floor to the ceiling. See Section 2.2, «Mounting the Camera Without Accessories» and the following sections for information on the different installation options; the drilling templates are available for downloading from [www.mobotix.com](http://www.mobotix.com), **Support > Download Center > Documentation > Drilling Templates**.

### 2.1 Preparing the Installation

Before mounting the MOBOTIX Q26, the following questions should be answered:

1. **Where will the camera be mounted?**  
Mounting to a ceiling or wall; see Section 2.1.1 and Section 2.1.2
2. **Which other mounting options are available?**  
On-wall mounting, in-ceiling mounting, vandalism protection, wall mounting, pole mounting, see Section 2.1.3
3. **How is the camera connected to network and how is power supplied?**  
MX-NPA-PoE or other PoE components (IEEE 802.3af), see Section 2.1.4
4. **How are the connections furnished from the building?**  
Wall outlets, see Section 2.1.5
5. **What cabling considerations are necessary?**  
Wiring, see Section 2.1.6 and Section 2.9

The following sections contain a brief answer to each of these questions, as well as references to the relevant sections in this manual. For more information on the MOBOTIX Q26 and available accessories, please see [www.mobotix.com](http://www.mobotix.com).



Wall installation with  
On-Wall Set 10°

## Preparing the Installation

### 2.1.1 Wall-Mounted

To make optimal use of the high-resolution 180° panorama functionality of the Q26, the camera must be mounted on an internal or external wall. The entire hemisphere of the room directly in front of the camera is then effectively monitored, from the wall on the left of the camera to the wall on the right. Corresponding fine-tuning in the user interface software allows the displayed panorama image to be adjusted to different practical applications (see Section 3.3, «Virtual PTZ and Full Image Recording»).



Wall installation with On-Wall Set 10°

The camera should preferably be mounted in the middle of the room to be monitored using the 10° On-Wall Set

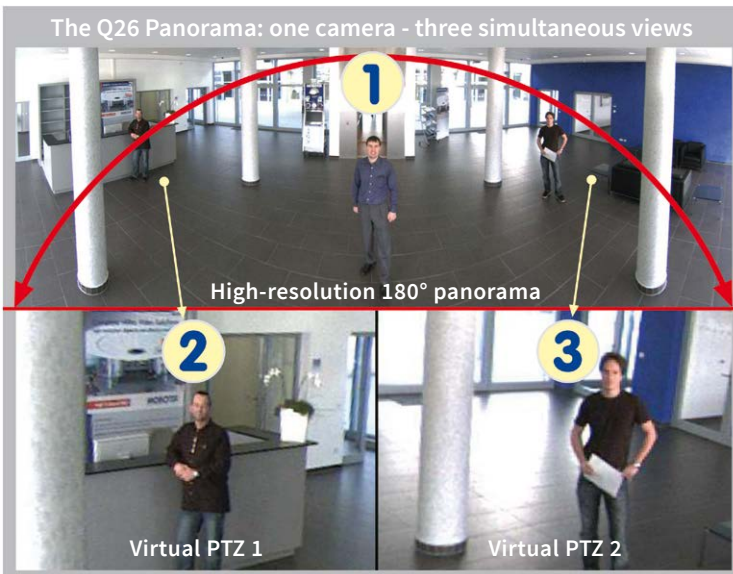

Original image from the camera shown above using the 10° On-Wall Set (Panorama Focus View)

## Selecting an Appropriate Camera Position

The Q26 is primarily suited to providing an excellent overview, and less suitable for more exact details. For active operation, the camera should be mounted at a (out of direct reach) height ranging from 2.5 to 3.5 m. People, for example, may be identified very well at distances of up to 1.5 m, and with sufficient detail at up to 3 m. Objects can be recognized even at distances of 5 m and more from the camera. During installation, ensure that the camera is focused on the most important areas of the room as directly as possible, in order to provide the desired level of detail recognition. For wall installation, use of the 10° On-Wall Set is ideal in many cases.

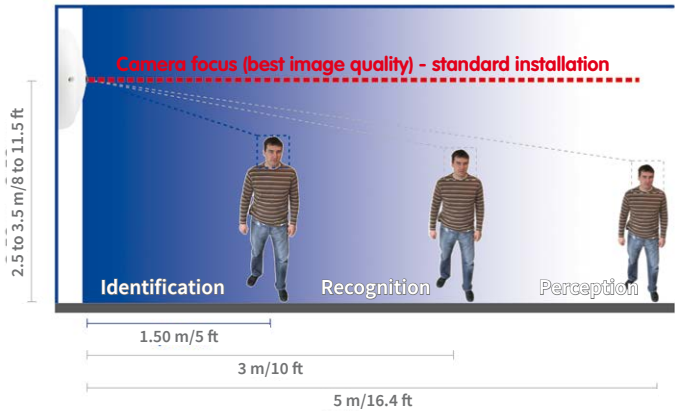

Wall Mount: Mounting the camera at the center of the wall



The OBEN / TOP label is only visible when the outer shell is removed

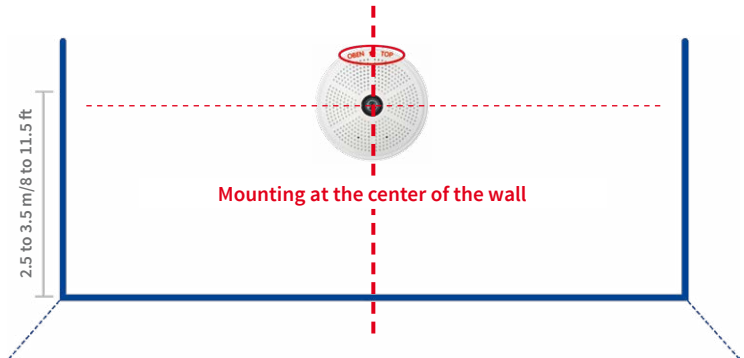

**Hint:** The Q26 should always be installed on a wall such that the arrow on the camera housing marked OBEN / TOP points towards the ceiling of the room.

## Preparing the Installation

### Wall Installation with the 10° On-Wall Set for Image Optimization

An on-wall set, available as an accessory in 0° and 10° inclinations, may also be used for installation. While the 0° set primarily offers easier installation and more storage space for cables and add-on modules (WLAN, connectors, etc.), the 10° set may also increase the image quality in certain cases. In particular for wall installations which must be carried out at greater heights for technical or other reasons (over doors, windows, etc.), adding a slight tilt to the camera, and thus also the lens, will return better results, as the center of the lens is then focused more directly on the center of activity in the room (optimal utilization of lens capabilities).

Optimized image quality through wall installation with On-Wall Set 10°

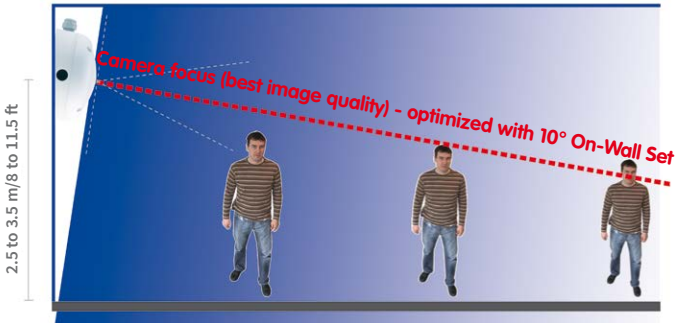

### Wall Mounting Over a Wall Outlet

Professional wall or ceiling installation of a Q26 is generally possible without accessories. However, due to elevation of the rear casing of the camera caused by connections and holders, a wall outlet should be installed prior to camera installation (see drilling template Q26). This provides perfect protection to the cabling, ensuring that it cannot be seen or damaged from outside.

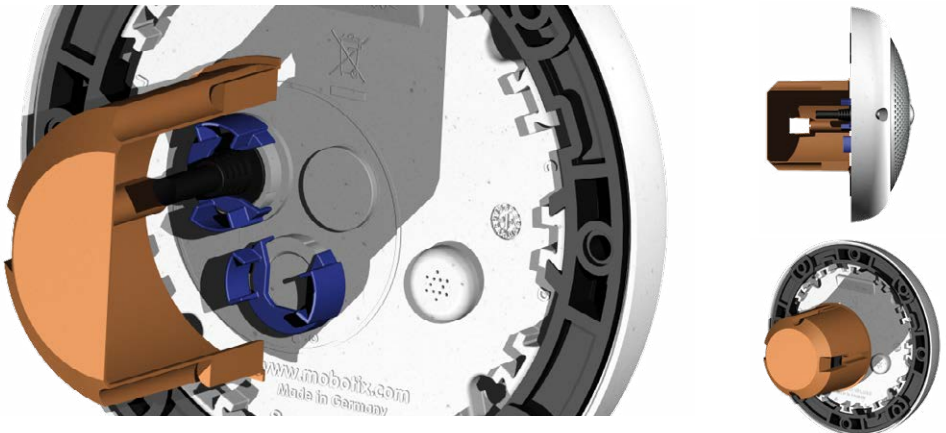

### 2.1.2 Ceiling-Mounted

Discreet ceiling installation using the In-Ceiling Set



Thanks to its hemispherical lens, a single Q26 can monitor an entire room right into each of the four corners (360° Panorama View). The camera's should ideally be positioned on the ceiling in the center of the room. Due to its inherent physical and optical properties, the precision of the lens decreases as the distance from the lens grows. This means that the maximum usable image area varies greatly depending on the intended purpose of the camera. Rooms with a square floor area of up to approx. 40 m<sup>2</sup> in general allow recognizing details even at the borders of the full image. If you would only like to know if persons enter a room, or to monitor specific objects, rooms of up to 100 m<sup>2</sup> floor area can be monitored using a single Q26.

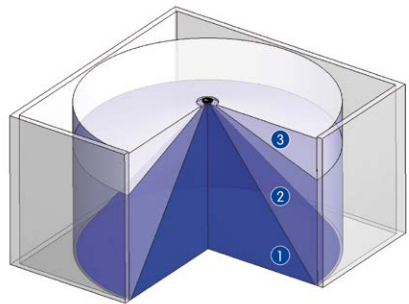

The image quality (precision) diminishes as the distance of an object to the camera focus point increases: 1 very good, 2 good, 3 satisfactory

Outdoors, the Q26 is usually mounted on a building wall, corner or pole instead of the ceiling.

For this situation, we recommend the use of the practical wall mount from the range of accessory products (see Section 2.6) or an extension.

## Preparing the Installation

### Non-Square Rooms

When viewing a 360° (full) image in the browser, you will notice that the top and bottom of the image is not fully visible, i.e. some image information has been clipped. This is not a fault of the camera, but intended behavior that aims at achieving the best possible utilization of the image sensor by the camera software. Bearing this in mind, it is advisable to install the Q26 in rectangular room ceilings so that the arrow marked OBEN / TOP points towards one of the longer walls of the room as shown in the figure.

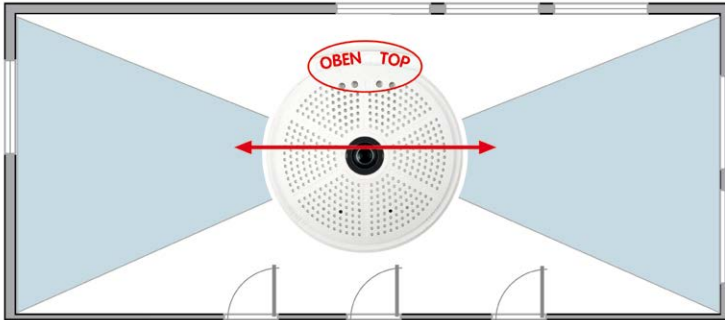

Original full image from the Q26 (ceiling installation in a rectangular room)

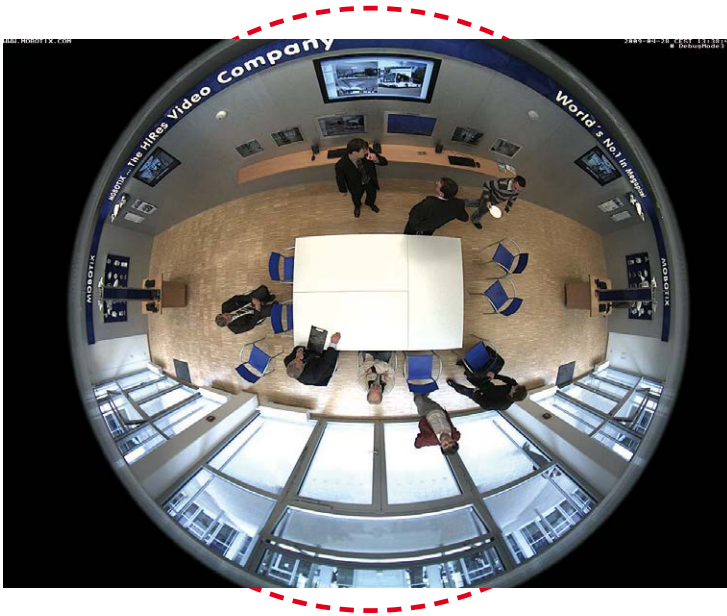

Never mount the camera to metal surfaces (condensation may damage the camera): MOBOTIX recommends using an On-Wall Mount or the Wall Mount

### Lowered Mounting or Mounting on Extensions

When mounting the camera in rooms with a high ceiling, or outdoors, it may be advisable to mount the camera in a lower position. This reduces the distance between the camera and the objects that are to be monitored, which in turn increases the recognizability of details. One practical solution would be to install the camera on a base plate attached to a suitable extension (metal tube) hanging from the ceiling. The network cable can be hidden from view by running through the interior of the tube.

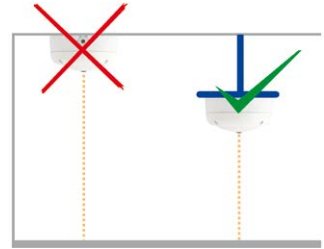

Similar to lowered mounting from the ceiling, you can also attach the camera to an extension mounted to a wall to better use the 360° image of the camera (e.g. outside, above a portal). Such an installation would use the pole mount accessory (MX-D22-OPT-MH) in conjunction with the wall mount (MX-D22-OPT-WH) as a sturdy base for the camera, which is then mounted to the extension pole.

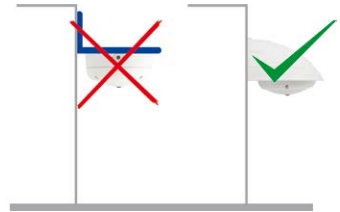

MOBOTIX does not recommend attaching the camera directly to metal carriers, especially when mounting the camera outdoors or when the ambient temperature varies greatly. As an additional measure to protect the camera against condensation, you should use either the On-Wall set (MX-D22-OPT-AP) or the Wall Mount (MX-D22-OPT-WH).

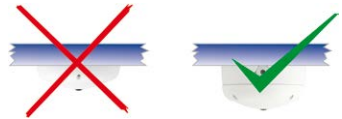

For the installation on building corners, the Corner and Pole Mount and a Wall Mount will be needed

### Installation on Building Corners with the Corner and Pole Mount

This is a special method of Q26 installation, offering substantial advantages for the outdoor surveillance of buildings.

The hemispherical lens of a single Q26 can cover the entire 270° range from one building wall to the other, for an “around the corner” view!

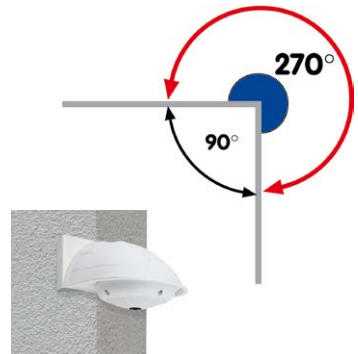



## Preparing the Installation

### 2.1.3 Mounting Options

#### On-Wall Installation (MX-OPT-AP)

The On-Wall Set can reliably protect external cables if the cables cannot be fed in the center below the camera housing. The On-Wall mount also provides ample space for extra modules.



On-Wall Set (IP65, for outdoor applications)

#### On-Wall Installation with 10° Inclination (MX-OPT-AP-10DEG)

This On-Wall Set is identical to the regular On-Wall Set, except that the mounted camera is tilted by 10 degrees. The inclination makes it possible for the camera to deliver the best images even in demanding situations.



On-Wall Set 10° (IP65, for outdoor applications)

#### In-Ceiling Installation (MX-OPT-IC)

The In-Ceiling Set allows the Q26 camera to be installed in suspended ceilings, for example. This type of installation provides optimum protection for the camera and reduces the visible profile to a minimum, since the camera only protrudes 24 mm from the ceiling.



Discreet in-ceiling installation; decorative outer ring also available in stainless steel

#### Vandalism Set (MX-Q26-OPT-VANDAL)

The Vandalism Set provides added protection for Q26 cameras. The set consists of a robust stainless steel cover (matt or polished) and an impact-resistant polycarbonate dome. A camera equipped with the Vandalism Set is perfectly suited for applications in demanding environments (such as prisons, trouble areas, train stations, etc.).



Vandalism Set (IP65)

#### Wall Mount (MX-OPT-WH)

The Q26/D25M Wall Mount is the ideal solution for mounting the to walls for indoor and outdoor applications. The camera is absolutely dustproof and resistant against water jets (IP65). The wall mount also covers RJ45 wall outlets and has ample space for additional modules.



Wall Mount made from sturdy PBT-30GF (IP65)

#### Corner and Pole Mount (MX-OPT-MH)

The MOBOTIX Corner and Pole Mount is the ideal choice when mounting the MOBOTIX Q26 to a pole or building corner (Panorama View covering approx 270°). This mount can only be used in conjunction with the wall mount. For poles with a diameter ranging from 60 to 180 mm.



Outdoor Corner and Pole Mount made from stainless steel (in conjunction with Wall Mount)

## Stand/Wall Mount for Camera Tests (MX-OPT-TW-Demo-1)



The Stand/Wall Mount is a useful accessory for testing and for finding the optimum mounting position of the camera. The set also includes an Allen wrench as well as a Torx screw with dowel and the corresponding Torx wrench for installing as alternative wall mount for testing.

### Using as a Stand (with/without tripod)

Using this stand, you can now place the camera upright on a flat surface or mount the whole assembly on a tripod (1/4" tripod thread at the bottom of the stand).

### Converting to a wall mount (simulation of On-Wall set with 10 deg. tilt)

1. If required, release the two stainless steel Allen screws and remove the camera from the stand/wall mount.

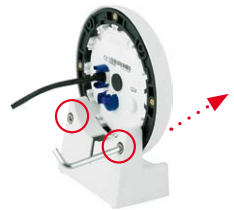

2. Place the camera with the two upper body screws exactly into the two receptacles of the Stand/Wall Mount. **Note:** The print on the camera back is upright.



Installation hint: The print on the camera back is upright.

## Preparing the Installation

---

3. Mount the camera to the stand using the two stainless steel Allen screws.



4. Use the Torx screw to fasten the mount onto the wall. Make sure that the head of the screw is not tight against the wall, but that it still has 5 mm/0.2 in in to go.

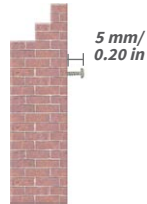

5. Slide the entire assembly from above over the Torx screw in the wall.

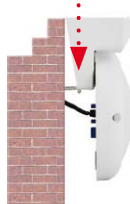

6. Properly tighten the Torx screw to secure the assembly in the desired position. There is a special hole in the Stand/Wall Mount to access the Torx screw.



### Caution

The Stand/Wall Mount has been only designed used for testing purposes. Make sure that you replace this mount by a proper wall mount before bringing the system into service.

### 2.1.4 Network Connection And Power Supply, UPS

The Q26 supports the Power over Ethernet standard IEEE 802.3af (PoE)

#### Power Over Ethernet (PoE Conforming to IEEE 802.3af)

All Q26 models are supplied with power using the PoE standard. The Network Power Adapter (MX-NPA-PoE-Set) may be used for smaller installations. For larger installations, it is worth investing in a PoE capable supply device available on the market.

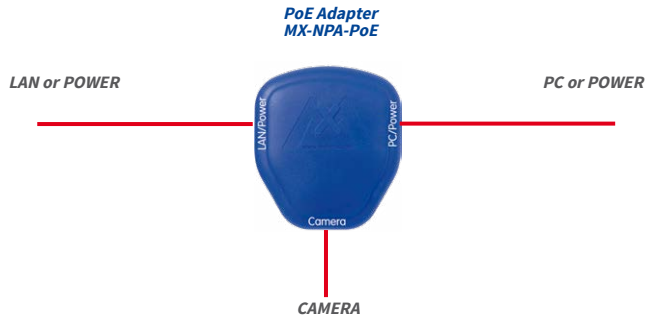

The Network Power Adapter replaces the crossover cable when directly connecting to a computer



The **maximum length** of the network cable for power supply over an Ethernet cable is **100 m**. The Mx2wire+ media converter set (available as an accessory) can be used to extend the range of an Ethernet connection up to 500 m in length (maximum transmission speed for a 500-m cable: 45 Mbps and 12 W for the PoE device).

#### Note

The MOBOTIX Q26 can be powered by switches or routers which support the PoE (Power-over-Ethernet) standard and conform to IEEE 802.3af.

#### Advantages of PoE power supply:

- Allows setting up centralized backup power supply via the network.
- Reduces energy consumption.
- No extra network connection for camera required.

## Preparing the Installation

### Using Uninterruptible Power Supplies (UPS)

You should install an uninterruptible power supply (UPS) in order to maintain a continuous power supply even when utility power fails. These devices also provide full protection against electrical surges and voltage fluctuations, enhancing the reliability of the system as a whole.

When using a more powerful 19" rack-mounted UPS, you can also protect all other network components (for example, switches, routers, PoE switches, etc.).

Since MOBOTIX cameras do not require any heating, even during winter, the average power consumption of approx. 3.5 watts is very low. This, in turn, means that you can centralize the UPS-protected power supply by injecting power into the Ethernet cables (max. 100 m). This kind of protected power supply can be used either with MOBOTIX PoE products (MX-NPA-PoE + Universal Power Supply) or with PoE-compliant switches according to IEEE 802.3af.



UPS units not only protect the camera against power failures, they also protect all other connected network devices against damage from voltage peaks and lows

19" system with UPS

### 2.1.5 Preparing the Camera Connections, MX-Overvoltage-Protection-Box

Once the camera position, the position of the cable outlets and the method of power supply have been decided upon, the cabling can be installed. Before installing the MOBOTIX Q26, you should make sure that the network connections have been properly tested so that the proper functioning of the camera is guaranteed.

If the camera is to be installed outdoors, you should also install the MOBOTIX MX-Overvoltage-Protection-Box (optional accessory). This interface box not only provides **overvoltage protection of up to 4 kV for MOBOTIX IP cameras**, it also provides simple and weatherproof connection of the cameras to a network patch cable (-RJ45 variant) or a network installation cable (-LSA variant).

For additional information on the MX-Overvoltage-Protection-Box, open the **Products > Accessories > Interface Boxes** section on [www.mobotix.com](http://www.mobotix.com).



### 2.1.6 Wiring, Fire Prevention, Lightning and Surge Protection

When installing the wiring inside or outside of buildings, make sure you always adhere to the relevant regulations on wiring, fire prevention and protection against lightning.

MOBOTIX cameras are protected against the effects of small electrical surges by a range of measures. These measures, however, cannot prevent the camera from being damaged when stronger electrical surges occur. Particular care should be taken when installing the camera outside to ensure proper **protection against lightning**, as this also protects the building and the entire network infrastructure.

MOBOTIX recommends having MOBOTIX cameras installed only by certified specialists accustomed to installing network devices and having proper respect for the applicable regulations regarding lightning protection and fire prevention as well as the current technology for preventing damages from electrical surges.

#### Guidelines for Wiring

- **Data cable:** Make sure you only use double-shielded CAT5 or higher cable (**S/STP**) for Ethernet connections.
- **Outdoors:** Installing the camera outdoors requires special precautions and measures regarding the cables as well as lightning and surge protection (see below).
- **Wire lengths:** The cable segments must not exceed the maximum allowed cable lengths in order to ensure proper data transfer (see Section 2.9).
- **Avoiding induction:** When running data cables parallel to existing regular power lines or high-voltage wires, make sure you observe the minimum distances to the power cables.



#### Fire Prevention

When installing the power lines to the camera, make sure you always adhere to the country-specific regulations (e.g. VDE in Germany, IEEE in the USA) in effect on wiring and fire prevention at the site of the installation.

## Preparing the Installation

---

### Lightning and Surge Protection

In order to avoid damage to MOBOTIX cameras from overvoltages, you should always install the **MX-Overvoltage-Protection-Box**. This competitively priced and weatherproof network connector provides reliable protection against overvoltages of up to 4 kV; the box is easily installed in the Outdoor Wall Mount, for example (see Section 1.5.13, «MX-Overvoltage-Protection-Box»).

More information is available at an institution such as the International Electrotechnical Commission (IEC, [www.iec.ch](http://www.iec.ch)) or at a manufacturer of protection devices against lightning and electrical surges, such as Dehn ([www.dehn.de](http://www.dehn.de)).

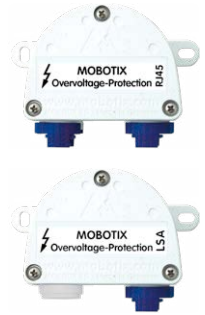

## 2.2 Mounting the Camera Without Accessories

### 2.2.1 Mounting Instructions

The Q26, being an overview camera, is primarily designed for installation on walls or ceilings. Direct installation of the camera without any accessories is, in general, always possible, however - due to elevation of the rear casing of the camera where connections and their holders are - a flush-mounted wall outlet should be installed first.

Installation over a standard flush-mounted wall outlet (minimum installation depth 20 mm/8 in)

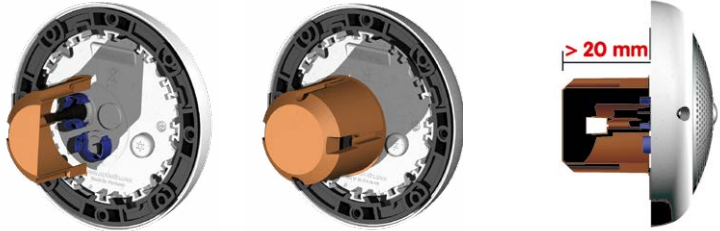

The drilling template also includes a blue circle marking the minimum size and position of this wall outlet, in addition to the drilling holes. To guarantee maximum coverage of the room by the camera, the Q26 should be positioned on the wall or ceiling as close to the middle of the room as possible.

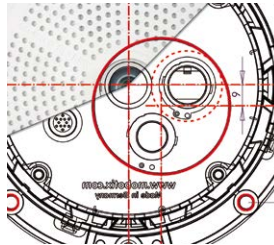



## Mounting the Camera Without Accessories

---

### Required Tools

Please check that all components supplied with the camera are present in the original packaging first (see Section 1.4.1, «The Q26 Camera»). The following additional tools are required for installation:

- Any additional materials for fastening the camera to a ceiling/wall, if necessary – 4 wood screws incl. screw anchors and washers are included in the original packaging.
- Screwdriver
- Power drill for screw anchor holes needed for ceiling/wall mounting
- MOBOTIX Drilling Templates (available for downloading from [www.mobotix.com](http://www.mobotix.com), Support > Download Center > Documentation > Drilling Templates)
- Scissors to cut out the template
- Pen to mark the drill holes
- Materials and any tools needed to connect the pre-installed MOBOTIX network cable in the camera with the on-site network cable.
- **Wall outlet and tools** to install the outlet in the wall/ceiling (keyhole saw)
- **Soft cotton cloth** to clean the front of the lens



Q26 seen from the side with cable bent properly

Due to the space required for cable and connectors, we recommend a flush-mounted wall outlet with an installation depth of at least 20 mm/8 in

## 2.2.2 Procedure

RJ45 patch cable: 50 cm (19.7 in) cable incl., other lengths available from MOBOTIX as accessories

Due to the space required for cable and connectors, we recommend a flush-mounted wall outlet with an installation depth of at least 20 mm/8 in

1. Install and prepare the **network connection**.
2. **Install the flush-mounted wall outlet:** The pre-installed cable attached to the camera must be connected with the on-site network cable. For installation without accessories, a flush-mounted wall outlet must be installed first, in order to provide a connection. The cabling is perfectly protected and cannot be seen or damaged. The camera cannot be mounted directly on top of protruding wall outlets. Use the camera drilling template (available for downloading from [www.mobotix.com](http://www.mobotix.com), Support > Download Center > Documentation > Drilling Templates) to mark the position of the wall outlet for the desired camera position.

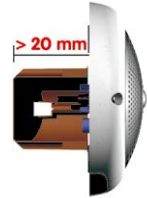
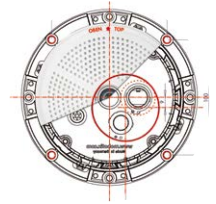

3. **Remove the outer shell:** Remove all four Allen screws using the supplied Allen wrench and lift off the outer shell.



4. **Drill the holes:** Drill the holes for the supplied screw anchors (see drilling template). Remember to take the proper direction of the camera into consideration (OBEN / TOP arrow pointing upwards for wall installation, or in the direction of the longer wall for ceiling installation in rectangular rooms).



5. **Connect the cable:** Connect the on-site network cable to the camera patch cable using a standard connector.



## Mounting the Camera Without Accessories

---

6. **Mount the camera:** Use the (included) screws to affix the mounting ring and the camera at the designated position.



7. **Install the rubber seal:** Place the rubber seal with the groove around the edge of the black mounting ring of the camera.



8. **Attach the outer shell:** Replace the outer shell and screw all four Allen screws tight using the supplied Allen wrench. Ensure that the rubber seal is properly positioned.



9. **Clean the lens:** If necessary, gently clean the front of the lens with a soft cotton cloth. Do not apply excessive pressure to the surface of the glass when cleaning the lens.
10. **Establish a connection to the camera, check the image:** Establish a connection to the camera as described in Section 3.1, «Manual and Automatic Operation – Overview» and the following sections. The live image from the camera should be visible on the computer monitor. Check image sections on the computer monitor as well.

### Caution

The **maximum torque** for all screws is **1 to 1.2 Nm**.

Only use the factory pre-installed network cable supplied with the MOBOTIX camera. Always ensure that the cable retainer with bayonet catch is closed properly around the network cable. All openings at the back of the camera housing except the pressure equalization element need to be sealed properly with the rubber plugs. This is the only way to guarantee that the camera remains weatherproof.

### Note

#### Note on fastening cables leading in to the camera:

Cables passing in to the back of the camera (patch cable for the network connection and ExtIO cable) are secured using a special cable retainer with bayonet catch.

When replacing this cable, ensure that the cable is properly seated in the connector and that the retainer with the blue bayonet catch is locked (short clockwise turn until it clicks into place).

#### Removing the Cable Retainer

Rotate the bayonet catch anti-clockwise to the “open circle” symbol (see figure). The catch may be removed from the side. The cable can now be pulled out of the camera.

Open the cable retainer by rotating the bayonet catch to the marked position

Bayonet catch open



## Mounting the Camera Without Accessories

### Caution

Only use **original MOBOTIX cables** to connect the camera. Standard cables purchased from other suppliers do not meet the necessary specifications for proper retention (no IP54 or IP65 weather protection).



*Ethernet patch cable*



*MiniUSB cable*

### Attaching the Cable Retainer

Insert the cable into the receptacle on the camera. Position the bayonet catch from the side (opening points to the right). Rotate the bayonet catch clockwise to the “filled circle” symbol (see image). The cable is now properly retained.



Close the cable retainer by rotating the bayonet catch to the marked position

Bayonet catch closed



### 2.3 Mounting the Camera with the On-Wall Set



#### 2.3.1 Mounting Instructions

On-Wall sets available in 0° and 10° inclinations allow fast and simple installation of the Q26 on a wall or room ceiling. When using the set outdoors (IP65), ensure that the screw holes on the rear of the camera housing are sealed with the included foam rubber washers.

It is not possible to install the on-wall set directly above an on-wall or flush-mounted outlet. Installation using the 10° On-Wall Set is often the right choice if a Q26 is to be used as a panorama camera installed at a greater than usual height (3 m or higher). Tilting the lens in the direction of the center of activity in the room maximizes image quality. Consider the desired camera position carefully during installation!

If discreet appearance of the Q26 is of particular importance, the In-Ceiling Set for ceiling installation is the best possible choice (see Section 2.6).

The network connection and drill holes must be prepared correctly before installing the On-Wall Set (both indoors and outdoors):

- **Network connection:** You can use any one of the four openings in the On-Wall set to guide the cabling into the camera. The network cable must be fed through the opening without a connector. An additional connector to connect to the camera cable is required. When preparing for installation, keep in mind that the camera must later be positioned in the correct orientation, according to its purpose (OBEN / TOP arrow pointing upwards for wall installation, or in the direction of the longer wall for ceiling installation in rectangular rooms).
- **Preparing the drill holes:** Use the drilling template for the Q26 On-Wall Set (available for downloading from [www.mobotix.com](http://www.mobotix.com), **Support > Download Center > Documentation > Drilling Templates**) to mark the position for drilling the anchor holes with regard to the camera position.

## Mounting the Camera with the On-Wall Set

### Caution

When using the On-Wall Set outdoors, ensure that the screw holes on the rear of the camera housing are sealed with the foam rubber washers included in delivery (IP65).

### Drilling Template On-Wall Set

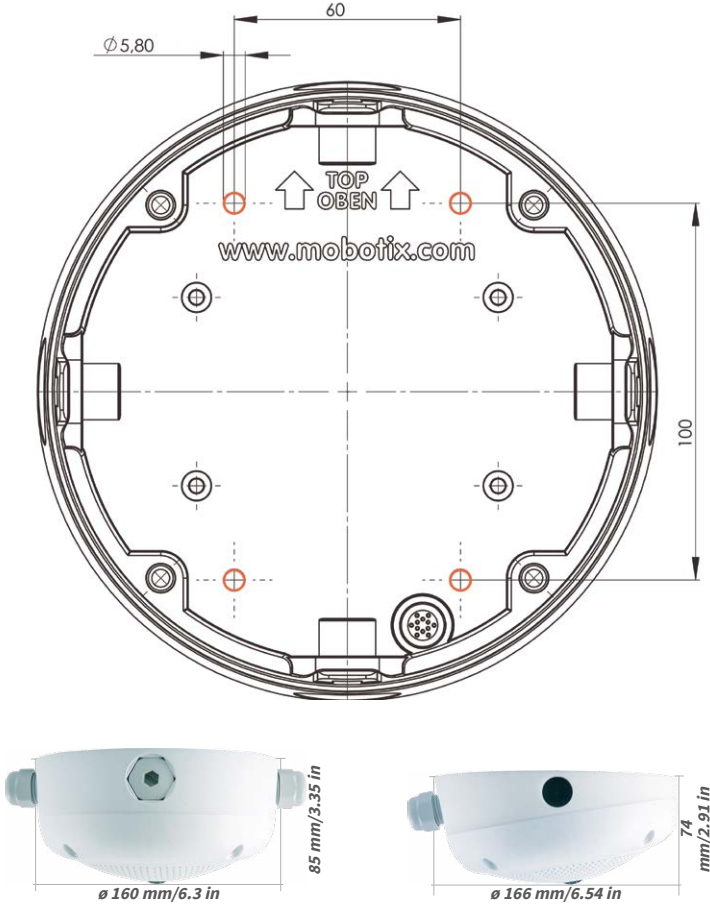

### Notes

Use the drilling template available for downloading from [www.mobotix.com](http://www.mobotix.com), **Support > Download Center > Documentation > Drilling Templates** (valid for both 0° and 10° On-Wall Sets).

Make sure that the drilling template is not scaled or adjusted to the paper size when printing the PDF file (enlarged or reduced).

The maximum torque for all screws is 1 to 1.2 Nm.

### Required Parts

Please check that all components supplied with the On-Wall Set are present in the original packaging first. The following additional tools are required for installation:

- **Suitable materials for ceiling/wall installation: 4 wood screws incl. screw anchors and washers (e.g. from the original camera packaging).**
- **Screwdriver**
- **Power drill** for screw anchor holes needed for ceiling/wall mounting
- **MOBOTIX Drilling Templates** (available for downloading from [www.mobotix.com](http://www.mobotix.com))
- **Scissors** to cut out the template
- **Pen** to mark the drill holes
- Materials and tools needed to connect the pre-installed MOBOTIX network cable in the camera with the on-site network cable.
- **Soft cotton cloth** to clean the front of the lens





## Mounting the Camera with the On-Wall Set

### 2.3.2 Procedure

1. **Attach washers:** Prior to installation, stick a black foam rubber washer around each of the four screw holes on the rear side of the on-wall housing (remove the adhesive foil and press into place, surface must be clean and free of grease). This prevents water from entering the housing.



2. **Prepare the cabling:** Insert the seal into the cable opening of the On-Wall Set such that the black rubber seal is on the outside. Fix it in place from the inside using a small hexagonal nut.



3. **Mount the On-Wall Set:** Mount the On-Wall Set (without the camera) at the intended position using e.g. the wood screws (included with Q26 camera, Pos. 1.13). Make sure the OBEN / TOP arrow points in the correct direction.



4. **Cable feeding:** Attach the counternut to the network cable, pass it through the seal from the outside and tighten the nut. The network cable is now screwed into the On-Wall Set, weatherproof. All unused openings must be sealed with the included sealant plugs. The cable passing into the housing must always be installed using the supplied three-part fittings.



5. **Remove the camera outer shell:** Unscrew all four Allen screws with the supplied Allen wrench. Remove the outer shell.



6. **Remove the mounting ring:** Separate the black mounting ring from the camera housing (lift the spring clip). This ring is not required when mounting the camera to the On-Wall set.



7. **Connect the cable:** Connect the on-site network cable to the network cable passing through the On-Wall Set using a standard connector. Excess cable can be stored easily within the On-Wall mount.



8. **Attach the camera to the mount:** The camera must be seated firmly within the On-Wall mount. The tapered guides at the back of the camera housing fit exactly into the openings of the On-Wall mount. Once, again, ensure that OBEN / TOP arrow points in the correct direction.



9. **Attach the outer shell:** Position the outer shell without the rubber seal and tighten all four Allen screws using the included Allen wrench.



10. **Clean the lens:** If necessary, gently clean the front of the lens with a soft cotton cloth. Do not apply excessive pressure to the surface of the glass when cleaning the lens.

11. **Establish a connection to the camera, check the image:** Establish a connection to the camera as described in Section 3.1, «Manual and Automatic Operation – Overview» and the following sections. The live image from the camera should be visible on the computer monitor. Check image sections on the computer monitor as well.

### 2.4 Mounting the Camera with the In-Ceiling Set



The decorative ring is available in different colors and in stainless steel

#### 2.4.1 Mounting Instructions

The In-Ceiling Set offers the most stylish installation option for the Q26. When properly installed, the only visible component is a particularly sleek and discreet hemispheric camera, while most of the remaining components are concealed inside the ceiling.

For these reasons, the Q26 installed with the In-Ceiling Set is the preferred option for most indoor spaces frequented by customers or the general public (e.g. hotels, restaurants, banks, retail stores, public buildings, etc.).

The common use of suspended ceilings in commercial and public buildings is an additional reason to place a preference on in-ceiling installation. The installation process is also simplified, as the network cable may be laid without difficulty and only a 15 cm diameter hole must be cut in the ceiling or ceiling component.

Before installing the MOBOTIX Q26 to an indoor location using the In-Ceiling Set, you must prepare the network connection and drill a hole for the camera:

- **Network connection:** The network cable is fed through the ceiling directly above the camera.

When preparing for installation, keep in mind (particularly with regard to cable slack) that the camera may later need to be repositioned in the correct orientation, according to its specific purpose (OBEN / TOP arrow pointing in the direction of the longer wall for ceiling installation in rectangular rooms).

- **Cut a hole for installation:** The hole should have a diameter of 150 mm (see drilling template available for downloading from [www.mobotix.com](http://www.mobotix.com)).

See Section 2.4, «Mounting the Camera with the In-Ceiling Set» for a detailed description

## Drilling Template In-Ceiling Set

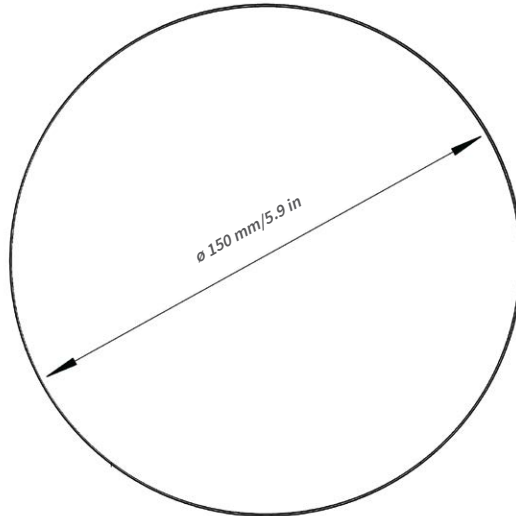

The In-Ceiling Set can be used in panels ranging from 6 to 22 mm/0.24 to 0.86 in thickness



### Notes

Use the drilling template available for downloading from [www.mobotix.com](http://www.mobotix.com), Support > Download Center > Documentation > Drilling Templates.

Make sure that the drilling template is not scaled or adjusted to the paper size when printing the PDF file (enlarged or reduced).

## Mounting the Camera with the On-Wall Set

---

### Required Parts

Please check that all components supplied with the In-Ceiling Set are present in the original packaging first. The following additional tools are required for installation:

- **Power drill with matching hole saw (150 mm diameter) or jigsaw**
- **MOBOTIX Drilling Templates** (available for downloading from [www.mobotix.com](http://www.mobotix.com))
- **Scissors** to cut out the template
- **Pen** to mark the hole positions
- **Two blue In-Ceiling wrenches** from the In-Ceiling Set
- Materials and tools needed to connect the pre-installed MOBOTIX network cable in the camera with the on-site network cable.
- **Soft cotton cloth** to clean the front of the lens



### 2.4.2 Procedure

1. **Prepare the network connection:** Run the network cable above the suspended ceiling and ensure that enough cable slack is available.
2. **Cut a hole for installation:** Cut a round hole for camera installation (e.g. with a 150 mm hole saw). Use the supplied cutting template of the In-Ceiling Set (available for downloading from [www.mobotix.com](http://www.mobotix.com)).

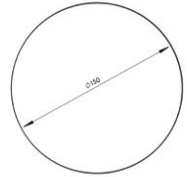

3. **Remove the outer shell:** Remove all four Allen screws using the supplied Allen wrench and lift off the outer shell.



4. **Remove the mounting ring:** Separate the mounting ring from the camera housing. This ring is not required when mounting the camera in the In-Ceiling Set.



5. **Place the camera in the In-Ceiling Set:** The dovetail guides at the back of the camera housing fit exactly into the openings of the In-Ceiling mounting ring.



6. **Connect the cable:** Connect the on-site network cable to the camera network cable using a standard connector.

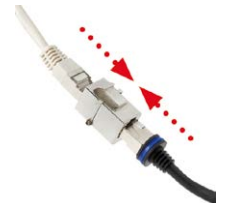

## Mounting the Camera with the On-Wall Set

- 7. Insert the camera and the In-Ceiling Set into the hole:** Make sure that all winged cams are retracted before placing the In-Ceiling Set with the camera into the hole. Pay attention to the orientation: the OBEN / TOP arrow should point in the direction of the longer wall for ceiling installation in rectangular rooms. Tightening the screws of the In-Ceiling Set extends the winged cams, thus firmly holding the set in place.



The blue winged cams (see left) automatically secure the In-Ceiling Set in the ceiling when tightening the screws



- 8. Install the decorative ring:** Use the two wrenches from the In-Ceiling Set to place the ring on the set as shown in the figure and turn the ring clockwise until it stops.



Installing the decorative ring: turn clockwise

The two wrenches from the In-Ceiling Set may also be used for **dismounting**. Insert them as shown and turn the ring counter-clockwise. Loosen the screws of the In-Ceiling Set; this will automatically retract the winged cams. You can now remove the In-Ceiling Set, with the camera still attached, from the ceiling.



Removing the decorative ring: turn counter-clockwise - only relevant when completely removing the camera

- 9. Clean the lens:** If necessary, gently clean the front of the lens with a soft cotton cloth. Do not apply excessive pressure to the surface of the glass when cleaning the lens.
- 10. Establish a connection to the camera, check the image:** Establish a connection to the camera as described in Section 3.1, «Manual and Automatic Operation – Overview» and the following sections. The live image from the camera should be visible on the computer monitor. Check image sections on the computer monitor as well.

### 2.5 Installing the Vandalism Set



#### 2.5.1 Mounting Instructions

The Vandalism Set serves to provide additional security and protection for Q26 cameras. It may be installed with little effort and at low cost. This set is recommended for use under particularly demanding conditions (such as prisons, trouble areas, train stations, etc.). The set consists of a robust stainless steel cover for the camera housing (matt or polished) and an impact-resistant dome cover made of reinforced plastic.

To install the Vandalism Set, simply mount the stainless steel cover and the included security screws (with the four mounted spacers) over the standard housing.

#### Scope of Delivery and Required Parts

Please check that all components supplied with the Vandalism Set are present in the original packaging first. The following additional tools are required for installation:

- **Allen wrench** for removing the standard outer shell (included in Q26 packaging)
- **Screwdriver with bit receptacle** for the two-hole driver bit
- **Clean and soft cotton cloth**





## Mounting the Camera with the On-Wall Set

---

### 2.5.2 Procedure

In order to install the Vandalism Set, replace the white plastic outer shell of the Q26, including the Allen screws, with the stainless steel cover, the security screws and the four spacers of the Vandalism set.

1. **Remove the outer shell:** Remove all four Allen screws using the supplied Allen wrench and lift off the outer shell.



2. **Remove the lens gasket:** Unscrew the lens using the lens wrench (included with the camera) and remove the lens gasket.



3. **Replace the lens:** Screw the lens back in using the lens wrench.



4. **Adjust the live image:** Establish a connection to the camera as described in Section 3.1, «Manual and Automatic Operation – Overview» and the following sections. The live image from the camera should be visible on the computer monitor. Select the highest available image resolution. Check image sections (image center and focus) on the computer monitor and adjust the lens with the lens wrench if necessary.

5. **Clean the lens:** If necessary, gently clean the front of the lens with a soft cotton cloth. Caution: Do not apply excessive pressure to the surface of the glass when cleaning the lens!



Lens wrench for installing the dome

Spacers for Vandalism set

Maximum torque for all screws is 1 to 1.2 Nm

Security screw and two-hole driver bit

Stainless steel cover must be positioned correctly to line up with the LED openings

6. **Mount the dome:** Screw the dome on in a clockwise direction using the supplied wrench. If required, clean the dome gently using a soft cotton cloth before completing installation. Check the sharpness of the camera image again, and correct it if necessary.
7. **Mount the spacers:** Place the four spacers on the mounting ring.

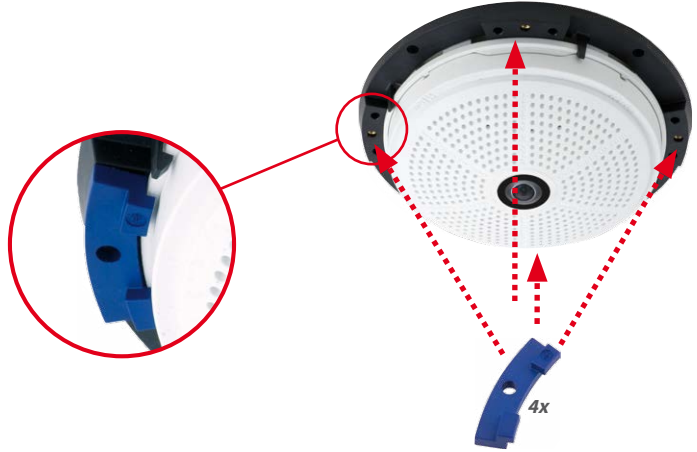

8. **Mount the stainless steel cover:** Position the stainless steel cover as shown and tighten the security screws using the included two-hole driver bit.



### 2.6 Installing the Wall Mount



#### 2.6.1 Mounting Instructions

The Wall Mount allows you to easily mount Q26 cameras to walls or extensions, both indoors and outdoors. The camera remains IP65 weatherproof (dust-proof and resistant to water jets). The Wall Mount also covers RJ45 wall outlets and has ample space for additional modules (WLAN, batteries, etc.).

**Before mounting** the MOBOTIX Q26 with the Wall Mount, you must prepare the network connection and drill the holes for the fixtures:

- The **on-site network cabling** is passed through the opening in the back of the wall mount. The cable and the required (standard) connector for the camera cable (patch cable) are ideally protected by a robust wall sealing made from foam rubber. Nothing is visible or accessible from the outside. The Wall Mount may be mounted directly on top of flush or protruding wall outlets. Maximum width x height of the outlet: 88 mm x 80 mm.
- Only use the Q26 **factory installed patch cable** (50 cm cable length) or a MOBOTIX cable of different length available from the range of accessories.
- All openings of the camera housing need to be closed off properly. This is the only way to guarantee that the camera remains weatherproof.
- The included screw anchors should be used for the **drill holes** in the wall. Use the drilling template for the Q26 Wall Mount (available for downloading from [www.mobotix.com](http://www.mobotix.com), **Support > Download Center > Documentation > Drilling Templates**) to mark the position for drilling the holes and the holes through which the cables will later be fed.



Direct installation over on-wall and flush-mounted wall outlets

## Drilling the Holes for the Wall Mount

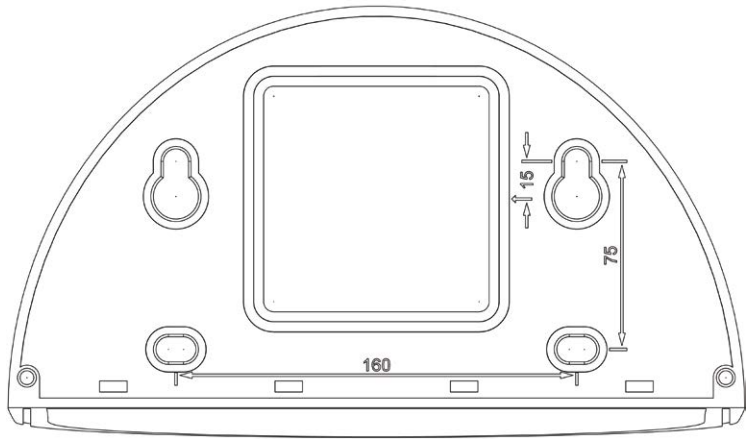

Direct installation over on-wall and flush-mounted wall outlets

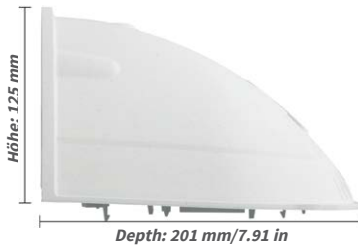

### Notes

Use the drilling template available for downloading from [www.robotix.com](http://www.robotix.com), Support > Download Center > Documentation > Drilling Templates.

Make sure that the drilling template is not scaled or adjusted to the paper size when printing the PDF file (enlarged or reduced).

## Installing the Wall Mount

---

### Scope of Delivery and Required Parts

Please check that all components supplied with the Wall Mount Set are present in the original packaging first. The following additional tools are required for installation:

- Power drill for screw anchor holes
- Screwdriver
- MOBOTIX Drilling Templates (available for downloading from [www.mobotix.com](http://www.mobotix.com))
- Scissors to cut out the template
- Pen to mark the hole positions
- **Materials and tools** needed to connect the pre-installed MOBOTIX network cable in the camera with the on-site network cable
- **Clean and soft cotton cloth**



### 2.6.2 Procedure

- 1. Remove the camera housing:** Remove all four Allen screws using the supplied Allen wrench and lift off the outer shell. The screws and outer shell will be needed again shortly.
- 2. Remove the camera mounting ring:** Separate the black mounting ring from the camera housing. This ring is not required when mounting the camera to the Wall Mount.
- 3. Separate the bottom plate from the Wall Mount:** The bottom plate is used to hold the camera and is only attached and screwed into place during a later step.
- 4. Pass the camera cable up through the bottom of the bottom plate:** Ensure the orientation is correct. The spring clips should be on the underside of the bottom plate.
- 5. Snap the camera into place on the bottom plate:** Firmly push the camera into the Wall Mount. The plastic spring clips will snap into place when the trapezoidal elements on the rear of the camera housing exactly match up with the corresponding openings on the Wall Mount. Pay attention to the direction of the camera (OBEN / TOP arrow pointing in the direction of the longer wall for ceiling installation in rectangular rooms).



## Installing the Wall Mount

---

6. **Mount the Wall Mount (without camera):** Stick the black wall sealing to the back of the Wall Mount (remove the adhesive foil first, the surface must be clean and free of grease). Pass the network cable through the large square opening and into the Wall Mount. Use the included screws to install the Wall Mount (without the camera) at the intended position. Pass the network cable through the large square opening on back side of the Wall Mount.



7. **Connect the cable:** Prepare the on-site network cable for connection with the camera patch cable using a standard connector. Excess cable can be stored easily within the Wall Mount.

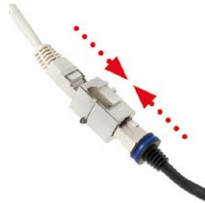

8. **Install the bottom plate with the camera in the Wall Mount:** Connect the camera patch cable to the network cable. Then mount the bottom plate with the camera in the slots from below and fix it in place on the Wall Mount using the 4 Allen screws (Allen wrench included).



9. **Attach the outer shell:** Position the outer shell (without the rubber seal) and tighten all four Allen screws using the included Allen wrench.



10. **Clean the lens:** If necessary, gently clean the front of the lens with a soft cotton cloth. Do not apply excessive pressure to the surface of the glass when cleaning the lens.
11. **Establish a connection to the camera, check the image:** Establish a connection to the camera as described in Section 3.1, «Manual and Automatic Operation – Overview» and the following sections. The live image from the camera should be visible on the computer monitor. Check image sections on the computer monitor as well.

## 2.7 Installing the Corner and Pole Mount



### 2.7.1 Mounting Instructions

The Corner and Pole Mount is made from stainless steel and is extremely robust and rust-proof. It is used in combination with the Wall Mount described in Section 2.6, in the case that a Q26 is to be installed on a pole or building corner. The Wall Mount required for complete installation must be ordered separately.

The mounting pole should have a diameter between 60 and 180 mm. Thanks to the 360° panorama view from above, installing the camera on the corner of a building makes it possible to monitor a range of approximately 270° from one building wall to the other (around the corner) with one single Q26 camera.

By design, the Corner and Pole Mount cannot be mounted above a wall outlet for the camera cabling.

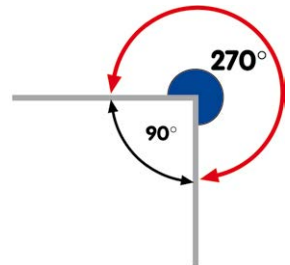



## Installing the Corner and Pole Mount

---

### Required Parts

Please check that all components supplied with the Corner and Pole Mount Set are present in the original packaging first.

The following additional tools are required for installation as a pole mount:

- **Screwdriver**
- Materials and tools needed to connect the pre-installed MOBOTIX network cable in the camera with the on-site network cable.

The following additional tools are required for installation of the corner mount:

- **Power drill for screw anchor holes**
- **Screwdriver**
- **Scissors** to cut out the template
- **Pen** to mark the hole positions
- Materials and tools needed to connect the pre-installed MOBOTIX network cable in the camera with the on-site network cable.



### 2.7.2 Mounting to a Pole



Use the supplied stainless steel straps to affix the Corner and Pole Mount to a pole.

- Guide the supplied **stainless steel straps** through the openings in the Corner and Pole Mount as shown in the figure. Make sure that you are using the slots of the mount that fit best for the thickness of the pole. The stainless steel straps allow attaching the mount to poles with diameters between 60 and 180 mm.



- Guide the on-site network cable from behind through one of the large round holes of the Corner and Pole Mount. In order to properly protect the cabling, it is best to pass the cabling from the inside of the pole through the Corner and Pole Mount directly into the camera (concealed cabling). **Note: The cable length from the pole should be at least 80 cm!**



- Tighten the **stainless steel straps** on the Pole Mount with a screwdriver. If necessary, the ends of the straps can be cut off.



### 2.7.3 Mounting to a Wall or Building Corner



Use the included screw anchors, screws and washers to affix the Corner and Pole Mount to a building corner.

- Mark the **four screw anchor holes** on the corner of the building, ensuring that the arrows on the mount point upwards. Drill the holes with a 10 mm wall drill.

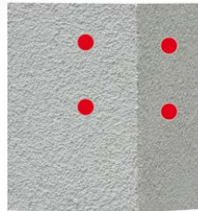

- Pass the on-site network cable through one of the large round holes at the back of the Corner and Pole Mount, then through one of the 16 mm diameter holes on the front of the mount. In order to properly protect the cabling, you should let the cabling run from the inside of the building through the Corner and Pole Mount directly into the camera (concealed cabling). **Note: The cable length from the building corner should be at least 80 cm!**



- Place the included **wall anchors** in the drilled holes and screw the Corner and Pole Mount into place on the corner of the building using the wood screws and washers. Use the drilling template (available for downloading from [www.mobotix.com](http://www.mobotix.com), Support > Download Center > Documentation > Drilling Templates) to mark the positions for drilling the holes.



- Next, install the Wall Mount on the Corner and Pole Mount (see next section).

### 2.7.4 Mounting the Wall Mount to the Corner and Pole Mount

- Feed the cables through the appropriate hole at the back of the Outdoor Wall Mount. The wall sealing on the Wall Mount must be in place already (see Section 2.6, «Installing the Wall Mount»).



- Use the 6x20 mm Allen screws, Ø 6 mm washers and M6 nuts included with the Corner and Pole Mount and **attach the Wall Mount to the Corner and Pole Mount.**



- Then continue with the remaining work steps described in Section 2.6.2!



## 2.8 Replacing the MicroSD Card

The camera must be taken down to remove, insert or replace a MicroSD card. To avoid data loss, be sure to deactivate MicroSD card recording in the camera software and reboot the MOBOTIX camera before removing the card.

### Caution

A MicroSD card may only be removed from the camera after you have deactivated Recording to SD Card and rebooted the camera. Failing to do so may lead to data loss!

### 2.8.1 Removing the MicroSD Card

1. **Deactivate recording:** Recording to MicroSD card must be deactivated (**Admin Menu > Storage on External File Server / Flash Device**). If MicroSD card recording is still active, deactivate recording and reboot the camera. Section 3.4, «MicroSD Card Recording», contains more information on this topic.
2. **Remove the outer shell:** Remove all four Allen screws using the supplied Allen wrench and lift off the outer shell.
3. **Remove the connection cables:** The connected cables (patch cable, MiniUSB if present) must be removed from the camera first by rotating and opening the bayonet catch (see «Removing the Cable Retainer» in Section 2.2.2, «Procedure»).



Bayonet catch open



Carefully loosen the rear casing at the openings on the side with a screwdriver before removing it.



4. **Remove the back of the camera and take out the MicroSD card:** Remove the four screws from the back plate using the supplied 2 mm Allen wrench and carefully lift off the back plate. Gently push on the MicroSD card in the card slot of the camera. The card will be released from the slot and can then be removed from the camera.



Push-push function: only remove the MicroSD card after first gently pushing it in



To use the camera without a MicroSD card, continue with step 2 in the next section.

## 2.8.2 Inserting a MicroSD Card

Push-push function:  
insert MicroSD card, then  
push until it clicks



Bayonet catch closed



1. **Insert the MicroSD card:** Push the MicroSD card into the card slot as shown, until an audible and perceptible click indicates it is in place.



2. **Mount the back plate:** Replace the back plate of the camera housing, ensuring that the back plate screw holes are correctly positioned above the thread inserts.



3. **Screw the back plate tight and replace the connection cables:** Place the four Allen screws back into the back plate and tighten the screws using the supplied 2 mm Allen wrench. The previously removed patch cable must now be reconnected (see «Attaching the Cable Retainer» in Section 2.2.2, «Procedure»).



4. **Attach the outer shell:** Replace the outer shell and screw all four Allen screws tight using the supplied Allen wrench.



5. **Activate recording:** If you have inserted a MicroSD card that has already been MxFFS formatted, you can activate recording under **Admin Menu > Storage on External File Server / Flash Device**. Once the camera has been rebooted, it automatically activates recording.

6. **If you have inserted a new MicroSD card,** it must first be formatted as described in Section 3.4, «MicroSD Card Recording».

### 2.9 Network and Power Connection, Additional Cables

#### 2.9.1 Notes on Cable Lengths and Power Supply

- Power is supplied to the camera via the camera Ethernet connection (patch or installation cable). We recommend using a MOBOTIX PoE adapter or another similar high-quality PoE product to loop-in the power supply:
  - **One camera:** with the PoE adapter (MX-NPA-PoE or MX-NPA-Box)
  - **Multiple cameras:** with PoE products conforming to IEEE 802.3af (PoE switch)
- The **maximum length** of the network cable for power supply over an Ethernet cable is **100 m**.
- Make sure that you only use switches or routers that support the **10/100 Mbps network interface** of the camera.
- We highly recommend using uninterruptible power supplies (UPS) to provide backup power.
- If you are using IEEE 802.3af or IEEE 802.3at (PoE+) Power-over-Ethernet network components to supply power to MOBOTIX cameras, make sure, if possible, that these components do not have a fan. Since the power consumption of MOBOTIX cameras is very low compared to other products, the reliability of the entire system is increased, thus extending the life of these components.

#### Caution

The power consumption of all attached **MxBus modules** must **not exceed 2.5 W**. When attaching modules to the MxBus connector **and** the USB socket, the **power consumption of all attached modules must not exceed 3 W, if the camera is powered by PoE class 3**. If **PoE class 2** is used, **the power consumption of all attached modules must not exceed 1 W!**

For more information on changing the PoE class, please see Section 2.9.8, «Variable PoE».

#### 2.9.2 Connecting the Q26 to the Network Using a Patch Cable

Using a patch cable and an MX-Overvoltage-Protection-Box or MX-NPA-Box offers the following advantages:

- Quick installation/deinstallation
- No shortening of cable even when installing/deinstalling several times
- Hose-proof/dust-proof connection in accordance with IP65
- Additional protection against overvoltages of up to 4 kV when using the MX-Overvoltage-Protection-Box.

### Connecting the Patch Cable to an MX-Overvoltage-Protection-Box, an MX-NPA-Box or a Standard Network Outlet

To establish the network connection of the camera using an MX-Overvoltage-Protection-Box or an MX-NPA-Box, remove the blue bayonet catch and the blue sealing plug from the right-hand side of the box. Insert the MOBOTIX patch cable into the box and fasten the cable using the blue bayonet catch.

For additional information on how to install an **MX-Overvoltage-Protection-Box** or an **MX-NPA-Box**, open the **Products > Accessories > Interface Boxes** section on [www.mobotix.com](http://www.mobotix.com).

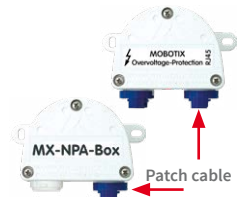

When using a standard network outlet (only for indoor installations), insert the MOBOTIX patch cable of the Q26 directly into the network outlet.

If additional cables are required inside the housing, they must be connected as described in Section 2.9.6, «Connecting a USB Cable» and Section 2.9.7, «Connecting a Two-Wire MxBus Cable».

### 2.9.3 Power Supply Using a Switch

1. Connect the factory pre-installed cable of the camera to the **camera** connector of the PoE adapter.
2. Connect the **LAN/Power** connector of the PoE adapter to the Ethernet connector of the switch/router or the Ethernet port.
3. Plug the RJ45 connector of the power supply unit into the **PC/Power** connector of the PoE adapter.

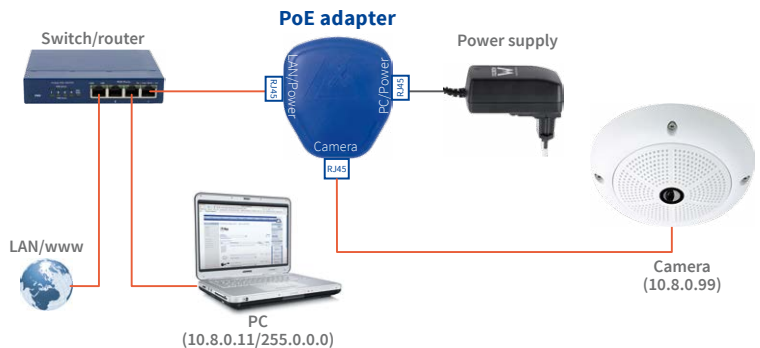



## 2.9.4 Power Supply When Connected Directly to a Computer

1. Connect the factory pre-installed cable of the camera to the **camera** connector of the PoE adapter.
2. Connect the **PC/Power** connector of the PoE adapter to the Ethernet port of the computer.
3. Plug the RJ45 connector of the power supply unit into the **LAN/Power** connector of the PoE adapter.

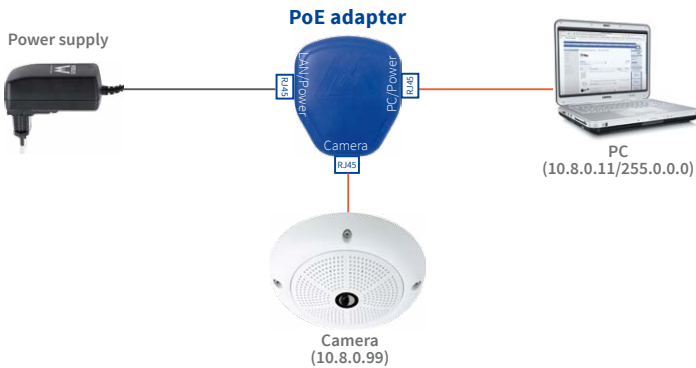

IP addresses in the figure are shown only as an example!

## 2.9.5 Power Supply with Power-Over-Ethernet Products

Connect the factory pre-installed cable of the camera to the Ethernet connector of the PoE switch/router. The switch/router must support the PoE standards IEEE 802.3af or IEEE 802.3at.



IP addresses in the figure are shown only as an example!

Only use USB cables with angled plugs inside the housing of the Q26!



### 2.9.6 Connecting a USB Cable

Using the USB plug (red circle in figure), you can attach existing expansion modules, such as the MOBOTIX ExtIO (USB), the MX-232-IO-Box or external USB hard drives to the camera in a weatherproof and well-protected manner.

#### Procedure

1. In case the camera had already been installed, remove the camera so you can access the connectors on the back.
2. **Remove bayonet catch and USB plug:** Turn the bayonet catch to the left (red arrow in figure), take it off and remove the blue USB plug.
3. **Connect USB cable:** Push the MOBOTIX cable with the angled MiniUSB plug into the connector (red circle in figure).
4. **Attach bayonet catch:** Attach bayonet catch and turn it clockwise until it gently snaps shut (see figure).

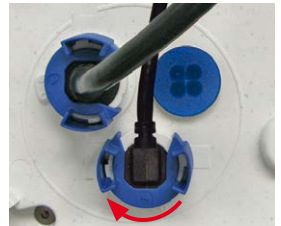
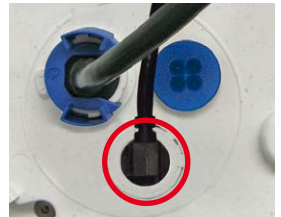
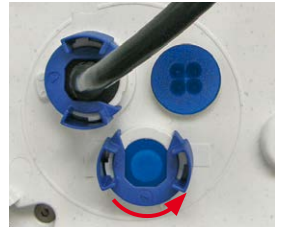

### 2.9.7 Connecting a Two-Wire MxBus Cable

You can use such a cable to connect additional MOBOTIX modules (e.g., the MX-GPS-Box or the MX-232-IO-Box) to the Q26.

Note that you can attach two MxBus cables (each having two wires) to the MxBus connector (red circle in figure). Take care not to switch the polarity of the wires. It is recommended to use the same wire color for +/- for the entire MxBus system (e.g., red = +, blue = -).



The length of the entire MxBus wiring must not exceed 50 m/55 yd.

#### Procedure

1. In case the camera had already been installed, remove the camera so you can access the connectors on the back.
2. **Prepare the MxBus wires:** Remove the blue single wire plug. Strip 5 mm (1/5 in) of insulation from the wire ends, then push each wire into one of the four holes in the single wire plug (this prevents humidity from entering the camera).
3. **Connect MxBus wires:** Push back the blue single wire plug so that you can easily attach the MxBus wires. Attach the MxBus wires by firmly pushing the wires into the corresponding connectors.

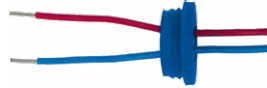

Single-wire plug



MxBus connector

If you need to remove one of the wires, unlock the connector by pressing on the orange-colored area using a small screwdriver, then pull out the wire.



4. **Close the MxBus connector:** Carefully press the single wire plug into the connector socket and twist the MxBus wire pairs.



## 2.9.8 Variable PoE

The power consumption of the camera depends on the functions in use as well as any peripheral devices connected (see table). PoE classes 1, 2 or 3 may be selected in the browser-based user interface in order to optimally adjust the camera to your system design (PoE switch in use, emergency power concept, etc.).

PoE Power Level Classes (IEEE 802.3af Standard)		
Class	Max. power consumption	Camera operating mode and peripheral devices
1	0.44 W–3.84 W	LowPower mode; no peripheral devices (available soon)
2	3.84 W–6.49 W	Normal mode; max. 1 W for MxBus peripheral devices
3	6.49 W–12.95 W	FullPower mode; max. 2.5 W for MxBus peripheral devices (for example, MX-GPS-Box and MX-232-IO-Box to MxBus), max. 4 W for peripheral devices to MxBus and USB interface

### Caution

If the total power consumption of the camera and peripheral devices exceeds the power provided by the PoE switch for the specified class, the switch can disconnect the camera from the power supply. **In this case, the camera will only be accessible again once the peripheral devices have been disconnected from the camera and the camera has been restarted.**

Variable PoE: Multiple cameras can be operated simultaneously from the same switch

The default setting is usually fine, and nothing needs to be changed. However, the PoE power class must be changed in the browser if a higher or a lower power class is required for your application:

1. Select Admin Menu > Network Setup > Ethernet Interface (for experts).
2. Click on Change under Power Supply.
3. A Power Wizard will appear to guide you through the PoE configuration steps.
4. Next, restart the camera: Disconnect the camera from the power supply. Then reconnect it, for example, by disconnecting and then reconnecting the Ethernet cable at the PoE switch.

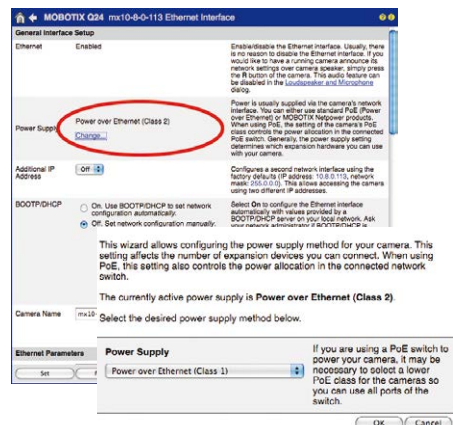



### 3 OPERATING THE CAMERA

#### 3.1 Manual and Automatic Operation – Overview

Download the free-of-charge MxManagementCenter software at [www.mobotix.com](http://www.mobotix.com)

MOBOTIX cameras do not require any extra software. Thus, you can set up and operate the MOBOTIX camera using a JavaScript-enabled browser on all common operating systems (such as Windows, Linux, Macintosh, etc.). As an alternative, you can also use the MOBOTIX application MxManagementCenter. Follow these steps to set up the camera:

1. **Connect the camera to the network.**

Power is supplied directly via the Ethernet cable (see Section 2.9, «Network and Power Connection, Additional Cables»)

2. **Establish a connection to the camera and adjust the network settings, if required.**

By factory default, MOBOTIX cameras are booting as DHCP client with an additional fixed IP address in the 10.x.x.x range (e.g., 10.16.0.128). Local computer networks usually have IP addresses in the 172 or 192 ranges. Depending on whether a DHCP server is present on the local network (e.g., a DSL router) or if the network has been set up to use fixed IP addresses, there are several possibilities for establishing a connection to the camera and to change its network parameters:

- **Network with DHCP server**

- **Using a browser:**

If you know the IP address that the DHCP server assigned to the camera, simply enter that address in the browser address bar to directly connect to the camera (see Section 3.2.2, «First Images and the Most Important Settings in the Browser»).

- **Using MxManagementCenter:**

With MxManagementCenter, you can show and integrate the camera without having to know its current IP address (see Section 3.2.3, «First Images and Network Parameter Configuration in MxMC»).

- **Network with fixed IP addresses**

In order to access the camera, it must have an IP address within the range of the local network. To set the camera's network parameters, you can use one of these methods:

- **Manually using a browser:**

First, you need to change the network parameters of your computer (see Section 3.2.1, «Manually Setting Up the Network Parameters in a Browser» and following ...).

- **Integration into MxManagementCenter with automatic adjustment of the camera's IP address:**

The camera is displayed in MxManagementCenter despite the fact that the IP address is not part of the local network. The application allows reconfiguring the network parameters accordingly (see Section 3.2.3, «First Images and Network Parameter Configuration in MxMC»).

### 3. **Configure the camera.**

Using the web-based user interface or MxManagementCenter.



Camera software  
in the browser

## 3.2 First Images and the Most Important Settings

Once the MOBOTIX camera has been connected to the network, you need to set up the camera's network interface accordingly. This step involves setting up and checking the network parameters of the camera. If your network has an active DHCP server or is already using an IP address in the 10.x.x.x range with a 255.0.0.0 network mask, you do not need to change the camera's network parameters. You can access the camera directly (see Section 3.2.2). If your network or computer does not use an IP address in the 10.x.x.x range (for example, in the 192 or 172 ranges), you should follow one of the following methods for changing the camera's network parameters:

- **Manual Setup** (see Section 3.2.1)
- **Automatic setup using MxManagementCenter** (see Section 3.2.2, «First Images and the Most Important Settings in the Browser»)

### Note

We will use a camera with the factory address 10.8.0.99 in the following examples. Replace this IP address with the IP address of your camera. You will find the IP address of your camera on a small sticker on the camera. Make sure that the IP addresses used in the following examples are not already being used by other devices in the network.

Pressing the key (see Section 1.4.1, «The Q26 Camera») will prompt the camera to announce its current IP address on the camera speaker

### 3.2.1 Manually Setting Up the Network Parameters in a Browser

You need a computer that is using a 10.x.x.x IP address in order to manually set up the network parameters of the MOBOTIX camera. The computer's network parameters usually have to be changed for this purpose.

#### 1. Change the Network Parameters of Your Computer:

##### Windows (XP, Vista and 7):

1. Open **Start > Settings > Control Panel > Network Connections**. Clicking on **Properties** opens the dialog box shown.
2. Double-click on **Internet Protocol (TCP/IP)**. On the **General** tab, activate the Use the following IP address option. Enter an IP address in the 10.x.x.x range in this field (for example, 10.8.0.11).
3. Once all dialog boxes have been closed, the computer will have the IP address 10.8.0.11.

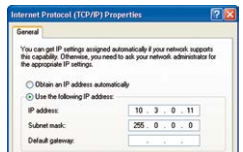

Entry in "Subnet mask" field: 255.0.0.0



# First Images and the Most Important Settings

## Windows 8.1/10:

1. Open **Start > Settings > Control Panel > Network Connections**. Clicking on **Properties** opens the dialog box shown.
2. Double-click on **Internet Protocol (TCP/IP)**. On the **General** tab, activate the Use the following IP address option. Enter an IP address in the 10.x.x.x range in this field (for example, **10.8.0.11**).
3. Once all dialog boxes have been closed, the computer will have the IP address **10.8.0.11**.

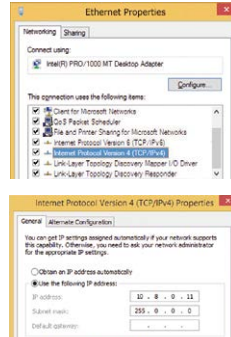

Entry in "Subnet mask" field: 255.0.0.0

## Linux/Unix:

1. Open a terminal as **root** user.
2. Enter the following command: `ifconfig eth0:1 10.8.0.11`
3. The computer is now also using the IP address **10.8.0.11**

## Mac OS X:

1. Open **System Properties > Network**.
2. Select **Ethernet**. In the **Configuration** field, select **Manual** and enter a **10.x.x.x** IP address (for example, **10.8.0.11**).
3. Click on **Apply** on the bottom right-hand side of the dialog box to assign the computer the IP address **10.8.0.11**.



### 2. Set Up the Target Network Parameters of the MOBOTIX Camera:

1. Open a web browser on the computer and enter the default IP address of the MOBOTIX camera in the address bar of the browser (for example, **10.8.0.99**). Pressing Enter displays the user interface of the MOBOTIX camera (see also Section 3.2.2, «First Images and the Most Important Settings in the Browser»).

#### Default user data

User name: **admin**  
password: **meinsm**

2. Click on the **Admin Menu** softbutton in the user interface of the MOBOTIX camera. The Quick Installation starts automatically once the admin user has logged on.

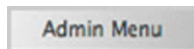

**Note:** The Quick Installation can also be executed at a later stage by opening **Admin Menu > Network Setup > Quick Installation**.

3. Enter the target network parameters of the camera on the appropriate page of the Quick Installation assistant.

**Note:** The network parameters can also be modified retroactively via **Admin Menu > Network Configuration > Quick Installation**.

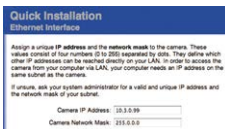

4. Once you have completed the Quick Installation and rebooted the camera, the new network parameters will be activated. The camera can now be connected to the target network and, if required, further configured.

### 3.2.2 First Images and the Most Important Settings in the Browser

Once the MOBOTIX camera has been connected to the power supply and to the network, you can access the user interface with the live camera image in the web browser. Internet Explorer, Firefox, Safari or any other graphical browser with activated JavaScript is suitable. It does not matter which operating system is used.

After entering the camera's IP address in the browser's address bar, you will see the live view of the MOBOTIX camera with its user interface controls, such as softbuttons, buttons for the different camera screens, pull-down menus (Quick Controls), icons for accessing the online help and the camera status, and status information elements.

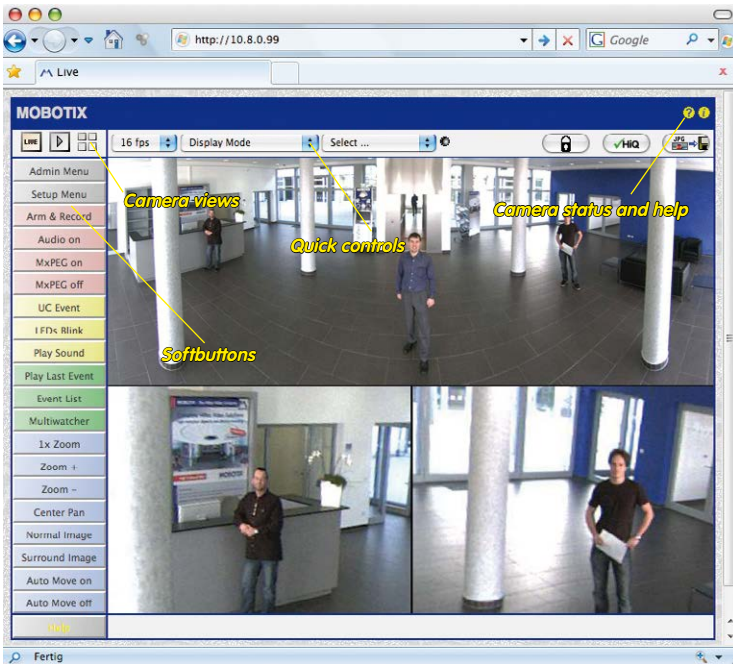

#### Note

Default access data for the administration menu

- User name: **admin**
- Password: **meinsm**

(Password must be changed upon first login – camera software V5.1.x and higher.)

## Camera Views: Live, Player, MultiView



Live view:  
<http://<camera IP>/control/userimage.html>

The MOBOTIX camera automatically displays the **live** screen when it starts up (factory default setting). You can set a different start page in **Admin Menu > Language and Start Page** (for example, the **Guest** screen) to allow a restricted access to the live image.

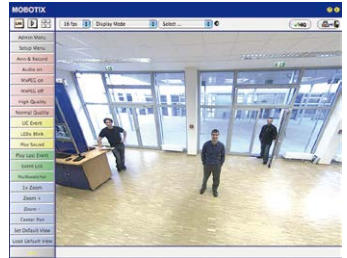

Player screen: <http://<camera IP>/control/player>

The other available standard screens include **Player** (playback of recorded images and video sequences) and the **MultiView** screen (displays several cameras with live or recorded images).



MultiView screen:  
<http://<camera IP>/control/multiview>

**MultiView** allows you to view several cameras via a “proxy” camera (especially useful if you want to access your cameras from outside of the network with reduced bandwidth) and the **PDA** mode provides a special screen for mobile devices.

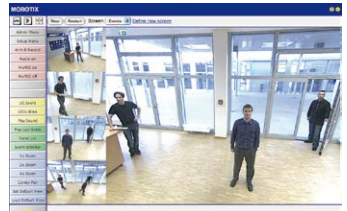

### Note

For more information on camera screens, see the online help of the camera's user interface.

## 3.2.3 First Images and Network Parameter Configuration in MxMC

### Installing and Starting MxManagementCenter

Download the current version of MxManagementCenter from the MOBOTIX website ([www.mobotix.com](http://www.mobotix.com) > Support > Download Center > Software Downloads in the MxManagementCenter area). Double-click the shortcut for the program or the program file.

### Finding Cameras

When starting MxManagementCenter for the first time, the configuration wizard opens and automatically starts searching for MOBOTIX cameras. The number of found cameras is shown next to the Add button. This number is updated automatically if the number of MOBOTIX cameras on the network has changed (i.e., by connecting new/disconnecting existing cameras)..

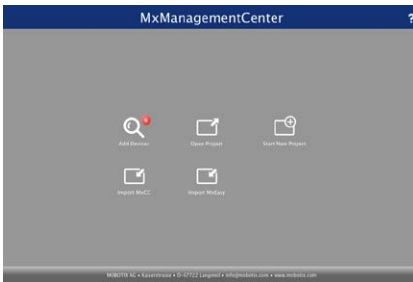

Download  
MxManagementCenter  
for free from  
[www.mobotix.com](http://www.mobotix.com)

Click on **Add Devices**. The cameras are displayed either in a list or as tiles. Use the **List** and **Tile** buttons to change the display mode.



MxManagementCenter automatically monitors and displays the operating status of all cameras. Cameras that are not on the same subnet as the computer are indicated by the icon (Camera not in the same network as the computer). Likewise, the cameras that have an unknown password or for which no user name/password combination has been specified in MxManagementCenter will be displayed with the (Camera is password-protected).

### Reconfiguring Network Addresses of Cameras

Using Bonjour\*, MxManagementCenter finds not only cameras on the same network as your computer, but also MOBOTIX cameras located in other subnets (status: ) . In such a case, you would not be able to establish any connection to cameras in a different network or subnet.

This is the case, for example, if you are integrating cameras into a network without DHCP server (i.e., with fixed IP addresses) and the IP address range is different from the 10.x.x.x range supported by the cameras in addition to DHCP.

MxManagementCenter can automatically configure such a camera so that it is “integrated” into your existing network. To do so, you have to select the respective camera and then click on the  button at the bottom of the program window.

The **Network Setting** dialogue opens.

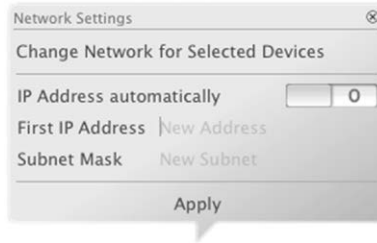

If you have assigned a fixed IP address to your computer, you will certainly prefer to assign fixed IP addresses to the cameras. To do so, enter the IP address and the subnet mask. The IP address is incremented automatically for each selected camera.

When you click on **Apply**, the selected cameras are automatically reconfigured and they are located in the same subnet as the computer.

## First Images and the Most Important Settings

### Adding Cameras

After a camera has been reconfigured, it has the status **Accessible** and can be integrated into MxManagementCenter.

Select the desired cameras (use **Cmd-click** to select several cameras). If the cameras are password-protected **1**, click on **Edit User and Password** **2** and enter the user name and password.

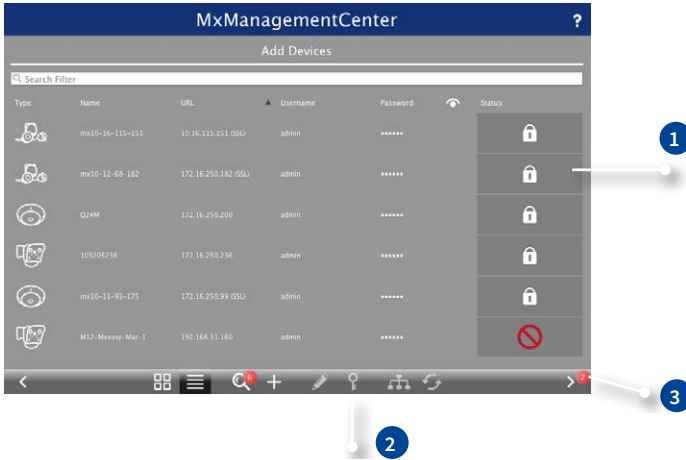

The number of selected cameras is shown on the **Next** button **3**. Move to the next page and click on **Finish**.

For more information, see the **MxManagementCenter Tutorial**, which can be downloaded as a PDF file from the MOBOTIX website: [www.mobotix.com](http://www.mobotix.com) > **Support** > **Download Center** > **Brochures & Guides** > **Tutorials**.

### 3.2.4 Start Options of the Camera

By default, the camera starts as DHCP client and automatically tries to get an IP address from a DHCP server. To start the camera in a mode different from the default mode, you can activate the boot menu of the camera.

#### Preparing the Camera

- Disconnect the camera's power supply.
- Make sure that you have suitable item such as a paper clip at hand, **but never use sharp or pointed objects!**
- Reconnect the power supply of the camera.

#### Activating the Boot Menu

The red LED lights up 5 to 10 seconds after establishing the power supply and will stay on for 10 seconds. Briefly press the key by inserting the paper clip into the hole indicated by the red circle in the figure. The camera enters the boot menu, ready for selecting one of the Start Options.

The LED now flashes once and repeats the flash signal after pausing for one second (the number of flashes indicates the current boot option). To go to the next boot option, briefly press the key again (< 1 sec). After the last boot option, the camera returns to the first option (LED flashes once).



LED default settings:

- 1 Power (on), Error (flashes)
- 2 Recording (flashes)

LED flashes	Boot Option	Meaning	Audio Confirmation*
1 x	—	This option is not used on this camera model.	—
2 x	Factory Defaults	Starts the camera with factory defaults (factory default IP address, users and passwords will not be reset).	<b>Boing</b>
3 x	Automatic IP Address	Starts the camera as DHCP client and tries to obtain an IP address from a DHCP server. If a DHCP server cannot be found or no IP address can be obtained, the camera starts with its factory default address.	<b>Boing Boing</b>
4 x	Recovery System	Starts the camera with the recovery system, e.g., in order to recover from a failed update of the camera software.	<b>Alarm Sound</b>

\*Only on cameras with audio option and installed speaker.

#### Selecting a Boot Option

Press the key longer (> 2 sec). The camera confirms the selection by flashing rapidly three times. You can now remove the paper clip. After 20 sec, the camera will confirm the selection by playing a sound according to the table above.

If nothing is selected, the camera will resume its normal boot process after a certain time.



### Starting the Camera with Factory (Network) Settings

If you use **boot option 2** to load the factory configuration, this configuration is not automatically saved in the camera's flash memory. When the camera is next rebooted without using boot option 2, the last stored configuration will be used. To permanently store the new configuration in the camera's flash memory, open **Admin Menu > Store**. Note that you can restore specific parts of the camera configuration afterwards by using "Restore" to re-apply the settings still stored in the camera.

As opposed to resetting the camera using **Admin Menu > Reset configuration to factory defaults**, the user information will **not** be reset if the camera is booted using the factory settings.

Make sure you store the default network configuration to the permanent flash memory

### Starting the Camera with an Automatic IP Address (DHCP)

If you use **boot option 3** to start the camera with an automatic IP address (DHCP), this is only **temporary**. The network configuration of the camera can be permanently set to DHCP (factory setting) under **Admin Menu > Ethernet Interface**.

Make sure that the network has a functioning DHCP server when starting the camera with DHCP support. If this is not the case, the camera cannot obtain a valid IP address and will use its last IP address.

You should also make sure that the cameras always obtain the same IP addresses by permanently assigning the MAC addresses of the cameras to the desired IP addresses.

In case of an error, the camera uses its last IP address

**Hint:** Briefly pressing the **key** will prompt the camera to announce its current IP address on the camera speaker.

## 3.3 Virtual PTZ and Full Image Recording

### 3.3.1 Preparing the Virtual PTZ Function

The virtual PTZ function allows you to use a mouse or joystick to continuously zoom in on images from the selected video source and “virtually” move the enlarged image section within the entire image sensor area.



Greater ease of use through a joystick

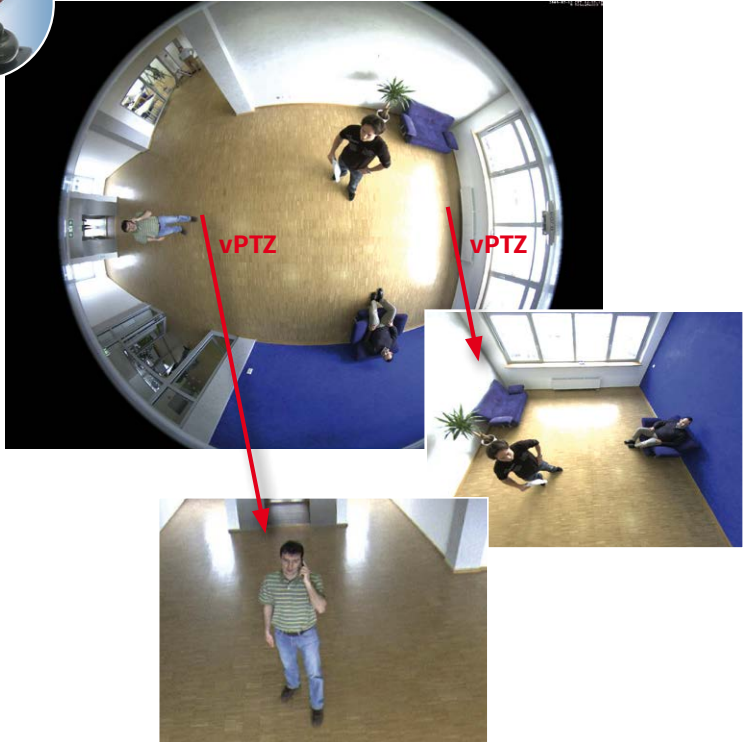

#### Operation Using the Mouse and Scroll Wheel

The vPTZ function of the Q26 can be controlled in the browser using the mouse. This position becomes the new image center by clicking on any position on the image displayed on the monitor. The image moves accordingly and the image distortion is automatically corrected. The **scroll wheel** can be used to control the zoom function. This functionality is disabled in the default settings of the camera and must therefore first be activated. To do this, go to **Setup Menu > vPTZ Settings**, disable **Lock Mouse Wheel Zoom**, click on **Set** and then on **Close** to save your settings. You can now use the scroll wheel to zoom in (roll upwards) or zoom out (roll downwards).

# First Images and the Most Important Settings

## Operation Using a USB Joystick

A standard USB joystick can drastically improve vPTZ operation for the user – in the browser and in MxManagementCenter. Please first install the joystick on the PC according to the manufacturer's instructions.

In order to use a USB joystick in the browser, make sure that you have a PC with a Windows operating system and the latest version of Internet Explorer and that the **“ActiveX” mode in the camera software (browser) is activated:**

- Switch to **Browser** in the Quick Control.
- Under **Browser**, select the option **ActiveX** in the field to the right. The USB joystick can then be used until the browser is closed.
- To store the setting permanently, **ActiveX** must be activated in the **Admin Menu**. To do so, use **Language and Start Page** in the Admin Menu.
- Under the page options, select the **ActiveX** operating mode.
- Store the settings permanently in the camera by clicking on **Set** and **Close**.
- The joystick can now be used.

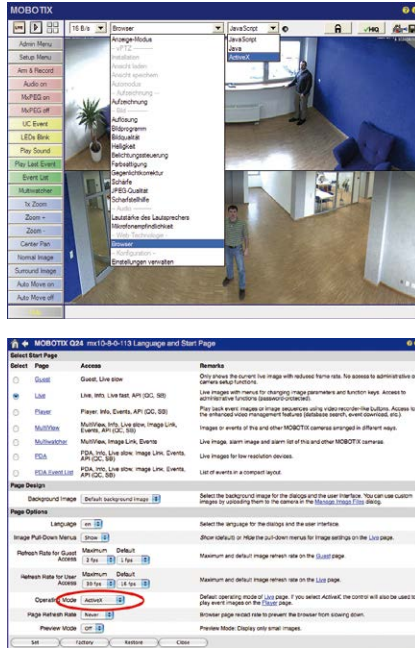

## Notes

You will find more information and details on the virtual PTZ in the “vPTZ Settings” topic of online help of the camera.

Current versions of all manuals can be downloaded anytime from the MOBOTIX website [www.mobotix.com](http://www.mobotix.com) under **Support > Download Center > Documentation > Manuals**.

### 3.3.2 Full Image Recording

It is possible to record a **full image**, regardless of the live image stream that is being displayed. This ensures that the recording always contains the full image of the lens used, even though the operator may have used the vPTZ features to zoom into the image in order to examine a specific detail.

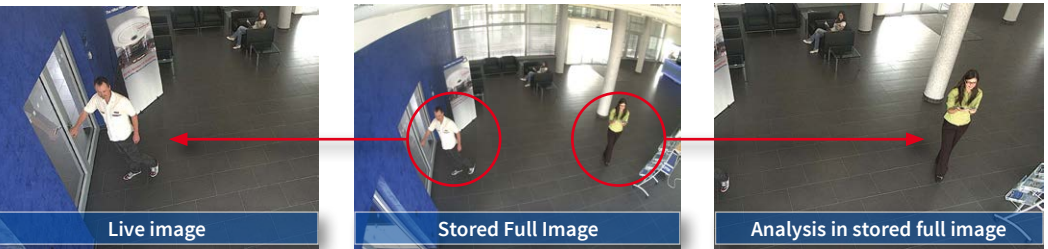

Stored full image:  
Original camera image  
without distortion or  
image correction

This means that you can use the vPTZ features in VGA resolution to pan, tilt and zoom in the live image while the camera is, for example, recording full images at 1 fps in MEGA or 6MP resolution.

In **MxManagementCenter**, the recorded full images may be prepared for the user with the vPTZ functions (for example, panning and zooming in on an image detail such as a doorway).

If **full image recording is not activated**, only the last displayed live image will be saved (save what is seen). The **main benefit** of live image storage is to ensure that the full power of the camera processor is used for live image correction and maximum frame rates. The **main advantage of full image recording** lies in the special functionality of the D14D, in that it can always ensure the availability of a maximum size (full) image for later searches, despite vPTZ actions carried out on the live image. The mechanical limitations of motor-driven PTZ cameras mean that they simply **cannot** provide this unique advantage to the user!

#### Notes

**Post-event search in the full image:** If you are using Full Image Recording on D14D cameras, you should use at least MEGA resolution when storing. This will facilitate later searches in **MxManagementCenter**. The advanced distortion correction features require this function to deliver satisfactory image quality.

**Full image recording on:** Due to the increased processing time, full image recording reduces the data rate of the live image stream, which may drop by around 10 to 30 percent. We therefore recommend reducing the frame rate for storage as much as possible to affect the live image stream as little as possible.

**Full image recording off:** The event that triggered a video motion (VideoMotion VM) window may not be in the recorded sequences while the window was not displayed at the time.

# First Images and the Most Important Settings

## Activate/Deactivate Full Image Recording in the Browser

To configure this feature, open the Setup Menu > Event Control > Recording dialog box and activate or deactivate the Full Image Recording option.

The screenshot shows the 'Recording' settings page for a MOBOTIX Q24 camera. The page is divided into 'General Settings' and 'Storage Settings'. In the 'General Settings' section, the 'Full Image Recording' option is set to 'On' and is circled in red. Other settings include 'Arming' (Enable), 'Digital Signing' (Off), 'Recording Status Symbol' (Off), and 'Terminate Recording (TR)' (Off). The 'Storage Settings' section includes 'Recording (REC)' (Event Recording), 'Include audio' (On), and 'Start Recording' (All). The 'Explanation' column provides details for each setting.

General Settings	Value	Explanation
<b>Arming</b>	Enable	<b>Arm Recording:</b> Controls camera recording. Enable: activate Recording. Off: deactivate Recording. St: Recording armed by signal input. CS: Recording armed by custom signal as defined in <a href="#">General Event Settings</a> . From Master: copies Recording arming state from master camera.
	(no time table)	<b>Time Table Profile:</b> Time table profile for time-controlled recording. ( <a href="#">Time Tables</a> )
<b>Digital Signing</b>	Off	<b>Digital Signing:</b> Digitally sign the recorded image files using the X.509 certificate of the web server. Manage X.509 certificates of the <a href="#">web server</a> .
<b>Recording Status Symbol</b>	Off	<b>Activate Recording Status Symbol:</b> On will draw a symbol in the image to visualize the current arming and recording status.
<b>Full Image Recording</b>	On	<b>Activate Full Image Recording:</b> On will always record the Full Image of the sensor with the specified parameters. On will record the visible image.
<b>Terminate Recording (TR)</b>	Off	<b>Activate Terminate Recording:</b> Terminate recording if an event is detected. Use this option to freeze stored images. <a href="#">Click here to resume recording.</a>
Storage Settings		
Attribute	Value	Explanation
<b>Recording (REC)</b>	Event Recording	<b>Recording Mode:</b> Type of event and story recording. Snap Shot Recording: stores single JPEG pictures. Event Recording: stores stream files for every event using MJPEG codec. Continuous Recording: continuously streams videodata to stream files using MJPEG codec.
	Include audio	<b>Record Audio Data:</b> Store audio data in stream file if available. Enable and configure <a href="#">microphone</a> .
<b>Start Recording</b>	All	<b>Start Recording:</b> Select the events which will start recording. Use (Ctrl)-Click to select more than one event. Events in brackets need to be <a href="#">activated</a> first. EC or EL for filtered events.

The screenshot shows the 'Full Image Recording' settings page for a MOBOTIX Q24 camera. The page is divided into 'Attribute' and 'Explanation' columns. The 'Image Size' is set to 'QXGA (2048x1536)', 'JPEG Quality' is set to '60% (High)', and 'Text Display' is set to 'Date & time'. The 'Explanation' column provides details for each attribute.

Attribute	Value	Explanation
<b>Image Size</b>	QXGA (2048x1536)	<b>Image Size:</b> Factory default: Mega (1280x960)
<b>JPEG Quality</b>	60% (High)	<b>JPEG Quality:</b> Factory default: 60%
<b>Text Display</b>	Date & time	<b>Text Display:</b> The Date & time option will only display date and time.
	Date & time	<b>Date and Time:</b> Select format of date and time.

### 3.3.3 Special Q26 Configuration in the Browser

Thanks to its hemispherical lens, the MOBOTIX Q26 provides certain special configuration options for the image settings. Depending on where the camera is mounted (ceiling or wall) and on the live image display preferred by the user, certain important basic settings and, if necessary, their adjustment must be configured when a Q26 is first installed.

A corresponding adjustment of the image setting is strongly recommended if the on-wall set is mounted with an inclination of 10 degrees (available as a Q26 accessory).

#### Configuration of the Q26 Basic Parameters

Complete the steps described below in the browser window:

1. **Log onto the camera and boot it** as described in Section 3.2.
2. **Select mounting position wall/ceiling/floor:** Click on **Installation** in the Quick Control panel and then select **Wall**, **Ceiling** or **Floor** according to the mounting position of the camera. **Ceiling** always means that the orientation of the camera or sensor module is from **top to bottom** and for **Floor**, the camera or sensor module's orientation is from **bottom to top**.

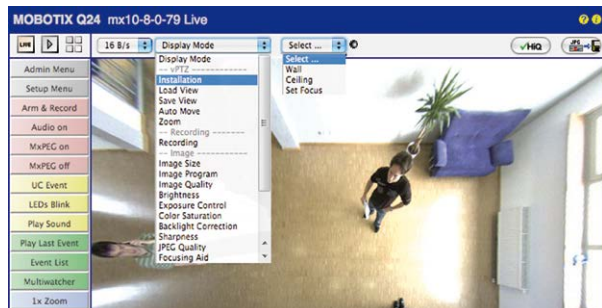

As a result, you will get a **perspective-corrected panorama** view for each image sensor matching the specified mounting position. Panorama view is set as a factory default and it can be changed as described below.

3. Switch to the **Display Mode** Quick Control.
4. Set the mode that you want to be the standard view. For demonstration purposes, the descriptions below describe the typical display mode for the wall mount and the ceiling mount, **Panorama** and **Surround** respectively. Every other display mode can be operated in the same way.

# First Images and the Most Important Settings

## Wall-Mounted: Setting and Correcting the “Panorama” Standard View



Camera live image with panorama correction

1. In the **Display Mode** Quick Control, select the option **Panorama**. Examine the image that is now displayed. If the section meets your expectations, no further adjustment is necessary and panorama configuration is complete. To change the image section to meet your specific expectations, continue with Step 2.

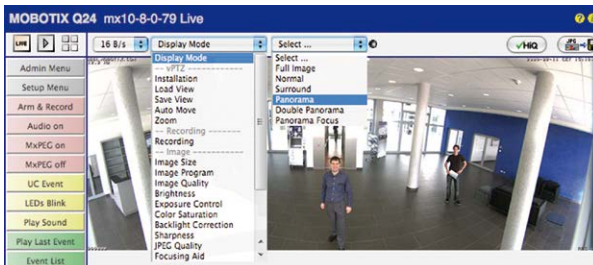

Camera live image **without** MOBOTIX panorama correction with Quick Controls visible

### Note

The currently visible image section may differ from the desired image section due to the installation position or any accessories in use, for example. However, it is not necessary to physically move the camera, as in this case the browser alone can be used to adjust the visible panorama image by zooming, panning and tilting. Tilted vertical lines may also be optically straightened to the image edges using the panorama correction function. These tilted lines are primarily caused if the camera or sensor module is tilted (for example, due to mounting with 15° wedges) or if the image tilt is modified.

- Click on the **lock icon**. Clicking on the lock once opens it (lock clasp is raised). The lock prevents execution of later vPTZ actions, which could also unintentionally modify the view you configure. This holds for all overview display modes, that is, also for Panorama/Focus, Double Panorama and Surround.



Open lock

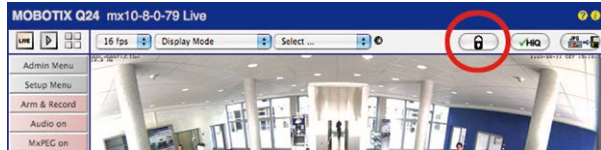

- A new **icon for processing the panorama image** appears in the top left corner of the camera image. Enlarge the image by clicking on the icon once (OnScreen Control appears).



Click on the icon



- Using the **OnScreen Control** visible in the live camera image, you can now change the displayed live camera image as desired (panning, tilting, zooming, rotating and panorama correction; see fig. on the right). When doing so, the vPTZ function using the mouse or joystick is deactivated. In case of a S15D with two sensor modules, click on the corresponding camera image (right/left) to edit it (highlighted with a yellow frame).

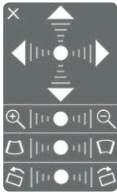

Camera live image with **panorama correction with OnScreen Control visible**

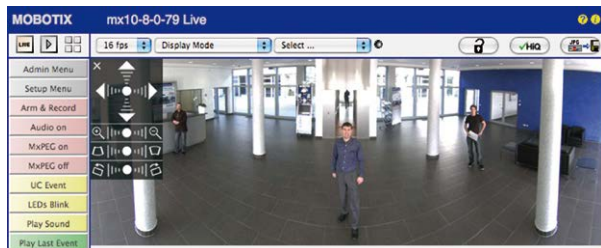

- After you have modified the desired setting, close the control panel (x in the top left hand corner).
- Click on the **lock icon again** to close it (lock clasp is down). The panorama image setting is then locked until the camera is next restarted.



# First Images and the Most Important Settings

## Caution

To permanently save the standard image setting defined for the Q26, go to the **Store Complete Configuration** option in the **Manage Settings** Quick Control. The settings will then remain in effect, even after rebooting.

## Functions Of The Q26 OnScreen Control

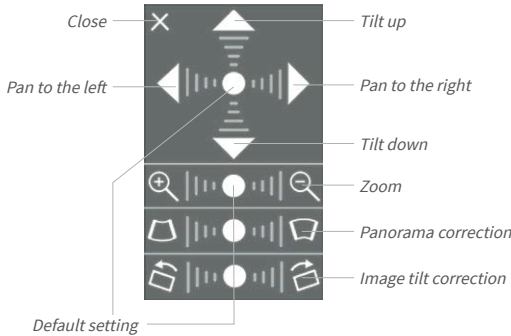

To use the OnScreen Control, click on the arrows in the top area for shifting the image section. In the bottom areas, which are displayed when needed, click to the left and/or right of the center point.

The same applies for every area: **The further away that you click from an area's center point, the greater the change triggered.** To reset an area, click on its center point again.

During panorama correction, clicking between the two trapezoid symbols straightens the left or right tilting lines, which are best visible at the edges of the image section.

Depending on the mounting position (ceiling, wall, floor), panorama correction and mounting error correction may not be available!



Bring columns together at the **top** (necessary to correct the example on the left)



Bring columns together at the **bottom**

## Ceiling-Mounted: Set North (User-Defined North Direction)

Once the Q26 has been mounted on a ceiling, you need to specify its North direction. This is not the “true” direction of North but rather the **main line of sight or the focus** of the lens. It serves as a reference for the North direction in the Surround and Double Panorama display modes (the **Ceiling** option was already selected in the Installation Type Quick Control).

1. In the case of a double image, click on the corresponding sensor module (camera image) and select the **Normal** option from the Display Mode Quick Control.



For vPTZ use and the configuration of a USB joystick, see Section 3.3.1

2. Rotate the live image in the desired direction using the mouse or a joystick connected to the computer.

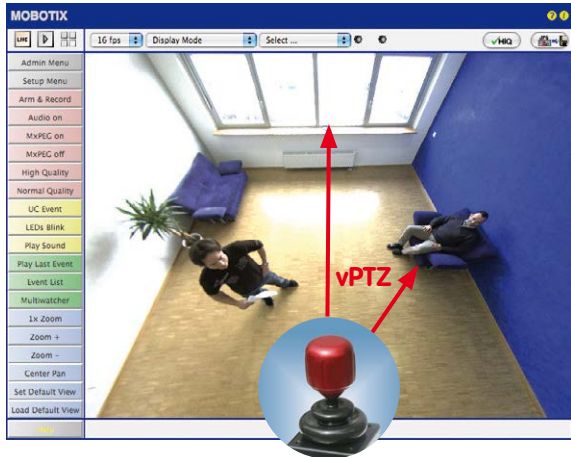

## First Images and the Most Important Settings

- In the Installation Quick Control, select the Set North option.

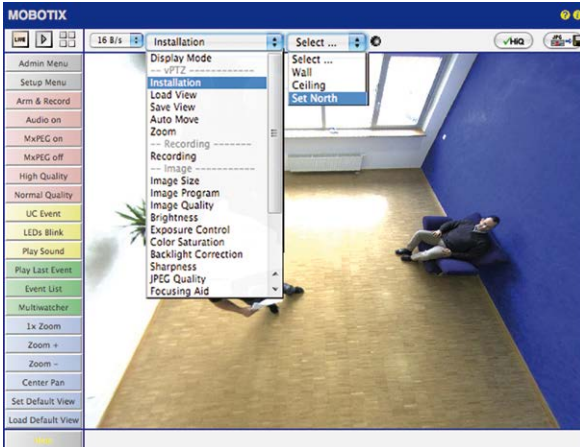

- Store the desired North direction permanently by first activating the checkbox and then clicking on Yes.

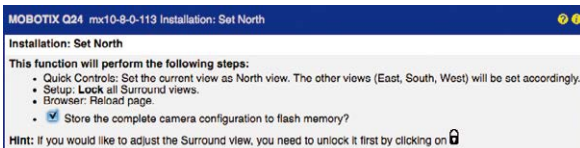

- You have now set the North direction for the Surround and Double Panorama display modes. In the next step, you can set these views as the standard view for the camera live image.



**Caution:** No OnScreen Control is available in "Double Panorama" mode

In the **Display Mode** Quick Control, select the option **Surround or Double Panorama**. You can fine-tune the views using the vPTZ via mouse or joystick and, as described above, by unlocking and locking the standard view using the lock icon (open lock, correct display and close lock again).

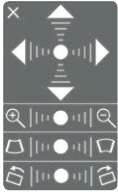

### Note

For each of the **subviews** (*North, East, etc.*), the **OnScreen Control** on the side can be used to adapt it (open lock, click on subview, adapt view, click on next subview, adapt view and close lock again).



### 3.4 MicroSD Card Recording

#### 3.4.1 Introduction

Flash-based storage devices (MicroSD cards, USB sticks and solid-state drives) do not contain any moving parts as compared to the commonly used hard drives. Flash-based storage devices are compact and highly resistant to moisture and vibrations. They feature low energy consumption and they do not lose any data in the event of a power failure, meaning that they are ideal for use with MOBOTIX cameras.



Flash memory devices: more robust than hard drives

#### Number of Write/Delete Cycles Per Flash Storage Cell

The number of write/delete cycles of every storage cell of a flash device is limited. The controller of the flash device automatically detects individual flash cells that are no longer functioning. The contents of the faulty cell will then be rebuilt using a checksum and will be moved to a properly working spare cell. The faulty storage cell will be marked as “bad” and will no longer be used. No data is lost in this process.

In addition, MOBOTIX cameras constantly monitor activated flash storage devices. MOBOTIX has developed a technology to test the wear of the flash device by logging the number of write/delete cycles (patent pending). The flash memory wear is automatically displayed in the status bar in the live camera image but it can also be viewed at any time in the **Admin Menu > Camera Status** dialog box.

#### Conservative Memory Usage Thanks to MOBOTIX MxFFS File System

MxFFS formatting of the MicroSD card means that MOBOTIX camera software will use the flash device as evenly as possible, thus allowing for the maximum possible number of write/delete cycles. This also means that all storage cells of the flash device will be written and deleted with the same frequency, if possible. MOBOTIX technology increases the life of the flash device considerably and also improves the security and the reliability of the storage process.

#### Storage Requirements and Life Expectancy of MicroSD Cards

The life expectancy of a MicroSD card increases proportionally to the storage capacity, since the camera software will execute fewer write/delete cycles on each storage cell. The first deletion will begin once the SD card has been filled to capacity (first full cycle).

All specifications are based on calculated averages

32 GB MicroSD Card: Storage Requirements					
	6 fps CIF	6 fps VGA		1 fps MEGA	1 fps QXGA
	M-JPEG	M-JPEG	MxPEG	M-JPEG	M-JPEG
File size single image	15 kB	45 kB	–	120 kB	240 kB
Storage required per second	90 kB	270 kB	75 kB	120 kB	240 kB
Storage required per 24 hrs	7.8 GB	23.5 GB	6.5 GB	10.4 GB	20.8 GB
Time for one full cycle	4 days	1.3 days	4.8 days	3 days	1.5 days

4 GB MicroSD Card: Storage Requirements					
	6 fps CIF	6 fps VGA		1 fps MEGA	1 fps QXGA
	M-JPEG	M-JPEG	MxPEG	M-JPEG	M-JPEG
File size single image	15 kB	45 kB	–	120 kB	240 kB
Storage required per second	90 kB	270 kB	75 kB	120 kB	240 kB
Storage required per 24 hrs	7.8 GB	23.5 GB	6.5 GB	10.4 GB	20.8 GB
Time for one full cycle	12 hours	4 hours	14.4 hours	9.2 hours	4.4 hours

### Caution

The MicroSD card's service life depends on production quality and frequency of use. Set the type of recording (event-controlled or continuous recording, frame rate, resolution) according to your specific requirements.

We recommend changing the pre-installed, high-quality MicroSD card once a year if you have it constantly set to continuous recording.

### Monitoring the Cell Wear of Flash Storage Devices (Patent Pending)

MOBOTIX uses its own technology for this purpose and has a pending patent. You can view the flash wear in the status bar of the live image or by opening **Admin Menu > Camera Status**. In addition, the camera can also send a warning message (for example, via e-mail) as soon as a critical error is detected when data is written to the SD card (**Admin Menu > Error Notification**). The MicroSD card can then be replaced to ensure that any existing data is not lost.

File Server / Flash Device	
Type	SD Flash Card
File System	MxFFS
Flash Wear	1%
Transfer Buffer Usage	0% (0: 0%, max: 0%)
Lost Event Images	0
Sequences	1 (1 files)
Newest Sequence	1970-01-01 01:00:00 #0
Oldest Sequence	1970-01-01 01:00:00 #0
Current Usage	4.0 MBytes (0.4%)
Max. Size	936 MBytes

## 3.4.2 Formatting the MicroSD Card

Before a MOBOTIX camera can store image and video sequences on a MicroSD card, the card needs to be formatted as MxFFS (MicroSD cards supplied by MOBOTIX are already MxFFS-formatted). The following steps are necessary to format a storage device (**Admin Menu > Storage on External File Server / Flash Device**):

1. Make sure that there is a MicroSD card in the card slot of the MOBOTIX camera.
2. Click **Format** in the **SD Memory Card** line.

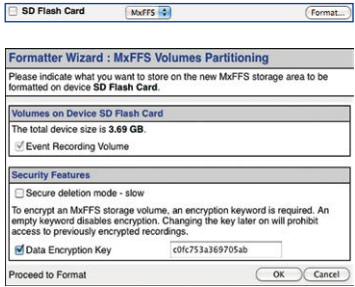

3. Note down the characters shown in the **Encryption password** field or enter your own password. Next, click **OK**.

**Note:** The **Secure deletion – Slow** option will ensure that any data on the MicroSD card is overwritten completely so that the data cannot be recovered in any way. However, keep in mind that this kind of safe formatting takes considerably more time.

4. In the next dialog box, enter the user name and the password of a user of the **admins** group and click **OK** to confirm.

The MOBOTIX camera now starts formatting the card. It takes 5 to 12 minutes to format an 8 GB MicroSD card if the **Secure deletion – Slow** option is disabled. If **Secure deletion – Slow** is enabled, this may take anywhere between 3 and 14 hours.



Once the formatting has been completed, you can activate the MicroSD card for recording (see next section).

Format SD card:  
**Admin Menu > Storage on External File Server / Flash Device**

The **Secure deletion – Slow** option takes several hours. You can also use suitable applications on Windows, Linux/UNIX and Mac OS X systems to repartition and safely erase the SD card.

### Caution

Make sure that you always wait until the formatting process has been completed before accessing the camera again. If the **Secure deletion – Slow** option is disabled, this usually takes just a few minutes. You can only access the MicroSD card once MxFFS formatting has been completed.

Formatting with the **Secure deletion – Slow** option enabled takes several hours. You can also use suitable applications on Windows, Linux/UNIX and Mac OS X systems to repartition and safely erase the MicroSD card.

Activate recording: **Admin Menu > Storage on External File Server / Flash Device**

### 3.4.3 Activating MicroSD Card Recording

Follow these steps to activate the recording to a MicroSD card that has already been MxFFS-formatted (**Admin Menu > Storage on External File Server / Flash Device**):

1. Make sure that there is a MicroSD card in the card slot of the MOBOTIX camera.
2. Make sure that the MicroSD card is formatted in MxFFS format.
3. Activate the **SD Flash Card** option.
4. Click on **Set** and then **Close** to store the configuration.
5. Reboot the MOBOTIX camera (**Admin Menu > Reboot Camera**).

Once the camera has rebooted, make sure that the camera displays the **FR REC** symbols in its live image. If this is the case, the camera uses the MicroSD card as recording target. If not, you must activate the recording (see below).

#### Activating The Recording

If the **FR REC** symbols are not visible in the live image after rebooting, you need to activate the recording using one of the following methods in the web browser:

- Automatic activation by clicking on the **Arm & Record** softbutton. Confirm this in the Easy Dialog by clicking on the **Yes** button.
- Manual activation via the Quick Control **Recording > Recording on** or in **Setup Menu > Recording**.

#### Encryption And Authentication

All video data stored on the MicroSD card is encrypted to ensure security at all times. The password for this is defined during the card's formatting procedure and needs to be entered for authentication whenever the recordings are accessed (see next section).



### 3.4.4 Accessing Data on the MicroSD Card

The following options facilitate access to the stored image and video sequences on a MicroSD card:

- **In the web browser:** Play back the recorded event images without audio directly from the MicroSD card using the Playback view of the camera software.
- **In MxManagementCenter:** Play back the recorded video sequences with audio by accessing the MicroSD card in the MOBOTIX camera via the camera or with a direct access to the MicroSD card via a card reader connected to the computer (coming soon).

#### Caution

When using the MicroSD card from one MOBOTIX camera in another MOBOTIX camera, you need to make sure that the time on the original camera is in sync with the new camera. We recommend using automatic time synchronization via a time server (Admin Menu > Date and Time).

### 3.4.5 Deactivating Card Recording

Follow these steps to deactivate the memory on a MicroSD card (**Admin Menu > Storage on External File Server / Flash Device**):

1. Activate the **None** option.
2. Click on the **Set** button at the bottom of the dialog box and then on **Close**.
3. Reboot the MOBOTIX camera (**Admin Menu > Reboot Camera**).

Once the camera has rebooted, make sure that the symbol **FR REC** is no longer visible in the bottom right-hand corner of the live image. You can now safely remove the MicroSD card from the camera (see Section 2.8, «Replacing the MicroSD Card»).

#### Caution

A MicroSD card may only be removed from the camera after you have deactivated the recording to MicroSD card and rebooted the camera. **Failing to do so may lead to data loss!**

Removing connected flash storage devices from the camera without properly deactivating them may lead to data loss and/or destroy certain areas of the storage device. This is limited to 4 MB of lost data per incident due to MxFFS formatting.

### 3.4.6 Using a MicroSD Card in a Different MOBOTIX Camera

A MicroSD card containing recorded video data from a MOBOTIX camera can be inserted into any MicroSD card-enabled MOBOTIX camera. Once a MicroSD card recording has been activated (requires a reboot), the “new” MOBOTIX camera automatically synchronizes with the card and resumes recording. No data is lost in this process. Make sure that you deactivate MicroSD card recording before removing the card and then reboot the MOBOTIX camera.

If the MicroSD card’s contents are encrypted, you need to enter the same password in the “new” camera in the **Admin Menu > Storage on External File Server / Flash Device** dialog box. Otherwise, the camera cannot access the MicroSD card.

### 3.4.7 Limitations on Warranty When Using Flash Storage Media

MOBOTIX will not assume any responsibility for flash storage devices (for example, MicroSD cards or connected USB storage devices) delivered with or integrated into MOBOTIX cameras. The same applies to damage to flash storage devices or damage resulting from the use of devices that are not supplied by MOBOTIX.

## 3.5 Configuration in the Browser

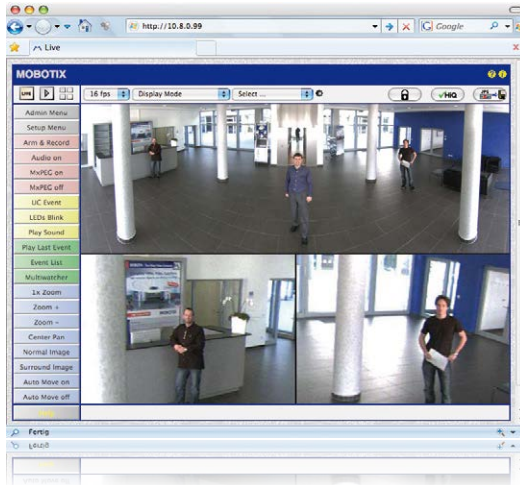

### 3.5.1 Overview

A MOBOTIX camera can be completely configured using a JavaScript-enabled browser on all common operating systems (such as Windows, Linux, Apple, etc.). The camera provides a HTML-based user interface for this purpose. The camera executes the changes you make to the camera configuration via HTTP commands using programs and scripts of the embedded software. The settings are stored in the camera's flash memory.

This section contains an overview of the basic browser settings of the MOBOTIX camera as well as further configuration options. Detailed information on the software functions is provided in the camera's online help.

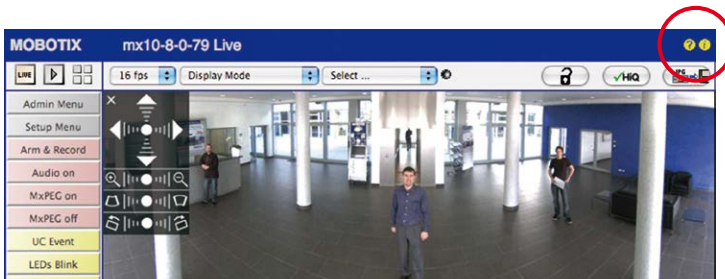

User name: **admin**  
password: **meinsm**

Admin Menu

Setup Menu

Make sure to permanently  
store changed parameters!

Automatic time synchroni-  
zation using a time server

**More:** Display  
advanced features

**Less:** Hide advanced  
features

### Basic Settings

- **Administering the camera:** You can modify the camera configuration in the Admin Menu or the Setup Menu.
  - **Admin Menu:** This menu contains the basic configuration dialog boxes of the camera (for example, passwords, interfaces, software updates).
  - **Setup Menu:** This menu contains the dialog boxes for configuring the image, event and recording parameters. Some of these settings can be changed using the corresponding Quick Controls in the live view.
- **Resetting changes:** If you would like to reset some larger changes in one dialog box without resetting the complete configuration, you can use the **Default** button at the bottom of the dialog box to reset only this dialog box's settings to the factory defaults. If you would like to reset all image settings, you can do so using the **Manage Settings > Restore Image Settings** Quick Control in the live image of the camera.
- **Storing changes permanently:** Once you have finished configuring the camera, you should always store the settings in the camera's permanent memory. You can do so in each dialog box (clicking on the **Set** button at the bottom of each dialog box will temporarily implement the change; when you click **Close**, you will be asked to store the complete configuration in the camera's permanent memory) or in the Admin Menu (**Admin Menu > Store current configuration into flash memory**). The **Configuration** section of the Admin Menu provides more functions for storing, copying and managing camera settings. For more information on this topic, refer to the online help for the specific dialog boxes.
- **Time tasks and time synchronization:** Apart from a multitude of possibilities for controlling the camera using time (time tables, holiday and vacation, scheduled tasks, etc.), the camera can also synchronize its internal clock. This allows you to manually synchronize the camera with a computer or automatically using a time server or another MOBOTIX camera. The camera can use either NTP time servers or Time Protocol servers. For more information on this topic, refer to the online help for the specific dialog boxes.
- **The "More" and "Less" buttons:** When opening some of the camera dialog boxes, the camera only shows the most important parameters. These dialog boxes have a **More** button in the bottom right-hand corner. Click it to display additional options. If all options are displayed, click on the **Less** button to hide the additional options.

### 3.5.2 General Browser Settings

- **Run the Quick Installation:** After booting a new MOBOTIX camera, accessing the administration menu for the first time will automatically start the Quick Installation assistant (**Admin Menu** button). The Quick Installation assistant helps you in setting the most important parameters of the camera. For security reasons, you should set your own administrator password and disable public access to the camera.
- **Disable public access:** Guest users are only allowed to access the Guest screen of the camera without entering a password. If this is not required, you should deactivate public access (**Admin Menu > Quick Installation** or **Admin Menu > Users and Passwords**).
- **Add users and assign access rights:** Similar to a computer operating system, you can add users and user groups and assign the desired rights (**Admin Menu > Users and Passwords**, **Admin Menu > Group Access Control Lists (ACL)**). This approach allows individual access rights to be assigned or denied to camera-specific features based on the user groups.
- **Deactivate the automatic reboot:** In its factory state, every MOBOTIX camera will automatically reboot at 3:36 a.m. every day. All images in the camera's storage buffer will be deleted during this reboot. Images stored on external file servers, internal flash storage, or SD cards will NOT be affected by this reboot. Make sure that you deactivate the automatic reboot if this is not desired (**Admin Menu > Time Tasks**).
- **Optimize the image settings:** The factory image settings of MOBOTIX cameras deliver excellent images for most application scenarios and should therefore not be changed. If you do wish to make changes, your changes should be minor and gradual. You should, however, set an image program according to the application scenario of the camera. Image programs provide a quick and simple method for adjusting the camera to the application scenario as they perform several configuration steps at once (**Image Programs Quick Control**).
- **Set the resolution of the live image:** By default, all MOBOTIX cameras are factory-set to an image resolution of 640x480 pixels. You can select the desired resolution using the **Resolution Quick Control**.
- **Adjust the exposure:** The automatic exposure control of the MOBOTIX camera uses individually configurable exposure windows to determine the best image exposure. Open the **Exposure Control Quick Control** and select a predefined set of exposure windows. If required, you can also define custom exposure windows (**Setup Menu > Exposure Settings**).
- **Activate event control and recording:** By default, the MOBOTIX camera's event control is disabled. Click on the **Arm & Record** button to activate event control. This will activate motion detection and recording. Cameras with integrated flash memory (MOBOTIX R models and models with an SD card) will automatically use the flash memory to store image and video data (recording target). If desired, you can set additional events and adjust the settings of the recording and storage parameters (**Setup Menu > Event Settings**, **Setup Menu > Recording** and **Admin Menu > Recording to External File Server / Flash Device**).

- **Set up actions/messaging:** Upon detecting an event, the MOBOTIX camera can trigger alarms. These alarms can be adjusted to your needs and you can assign them to a specific event: playing back an alarm sound on the camera speaker, showing the visual alarm in the camera live image, sending an e-mail or network message with the alarm image, placing a phone call, uploading an alarm image to an FTP server, switching a signal output line of the camera (for example, for switching on the lights/opening a door).

For the settings, see **Setup Menu > Action Group Overview**. The actions to be performed are defined and used in these action groups in the form of “action profiles.” The different action profiles can also be defined in the following areas: Admin Menu in the Hardware Configuration (profiles for signal output), Transfer Profiles (FTP, e-mail, network messages) and Sound and VoIP Telephony (sound profiles, VoIP profiles). For more information, refer to the online help for the **Action Group Overview** dialog box.

- **Activate shock detector:** The Q26 is also equipped with a shock detector as standard. If, for example, the camera’s housing receives a blow, it automatically registers it and sends a notification via a network message or telephone call. A general advantage is that MOBOTIX cameras are extremely tough because of the absence of mechanical moving parts. This allows them to stay fully operational when they are subject to strong vibrations. Open the **Setup Menu > Event Control > Environment Events > Edit** dialog box if you would like to activate the shock detector (and any other sensors).

### 3.6 Additional Notes

#### 3.6.1 Weatherproofness

The MOBOTIX Q26 has been certified according to protection class IP65 (absolutely dust-proof and resistant against water jets) and can also be wall-mounted outdoors using the corresponding wall mount.

#### 3.6.2 Password for the Admin Menu

Accessing the Administration Menu of the camera (**Admin Menu** softbutton) is only possible after entering a user name and password.

- Factory default user name is **admin**.
- Factory default password is **meinsm**.

(Password must be changed upon first login – camera software V5.1.x and higher.)

The **Quick Installation** assistant automatically appears when the Administration Menu is accessed for the first time. It provides an easy method to adjust the basic camera settings to the current application scenario. For security reasons, we highly recommend changing the default administrator password after the camera has been properly configured.

Enter the user name and password exactly as shown above. Note that all entries are case-sensitive.

#### Caution

Make sure that you store information on **user names and passwords** in a secure place. If you lose the administrator password and cannot access the administration menu, the password can only be reset at the factory. This service is subject to a fee!

#### 3.6.3 Permanently Deactivating the Microphone

Deactivating a camera's microphone may be necessary in order to protect the privacy of persons at a workplace or for other reasons. You can permanently and irreversibly deactivate the microphone in the **Admin Menu > Loudspeaker and Microphone** dialog box.

The microphone can be irreversibly deactivated!

#### Caution

This **deactivation occurs in the camera module itself and cannot be reversed**, even at the factory. Deactivating the microphone will also deactivate all functions that are making use of the microphone.

### 3.6.4 Using the Start Options of the Camera

- To reset the camera to factory settings and to use the factory IP address, please use **boot option 2** as described in Section 3.2.4, «Start Options of the Camera».
- To start the camera as a DHCP client and to automatically obtain an IP address, please use **boot option 3** as described in Section 3.2.4, «Start Options of the Camera».

#### Note

All defined users are deleted and the admin password is reset to the factory default when you reset the camera using **Admin Menu > Reset**. Use **boot option 3** as described in Section 3.2.4, «Start Options of the Camera» if you would like to maintain the existing users.

### 3.6.5 Activating Event Control and Motion Detection

In its default configuration, the camera's event control and video motion detection features are not enabled. In order to activate event-controlled recording, open **Setup Menu > General Event Settings** and activate the Arming switch. Another method is to click on the **Arm & Record** softbutton in the browser's user interface. The camera displays the motion detection window in the live image (dotted frame in the center) and the camera automatically stores images as soon as the motion detection window detects movements.



If the dotted rectangle in the live image is visible, the camera is armed

Text and logos can be also deactivated or individually configured

### 3.6.6 Deactivating Text and Logo Options

As camera arming is deactivated in the camera's default configuration (see preceding section), the MOBOTIX camera only displays the text **www.mobotix.com**, the time stamp and the MOBOTIX logo at the top of the image. Once the camera arming has been activated, the text at the bottom of the live image (event, action, messaging and recording symbols) will also appear.

You can deactivate the status bar at the bottom of the live image and the text bar in the top left-hand corner by setting Text Display in the **Setup Menu > Text & Display Settings** dialog box to **Off**. Setting Text Display to **Date and Time** will only display the time stamp in the live image. To hide the logo in the live image, open **Admin Menu > Logo Profiles** and set **Logo Display** to **Deactivated**.

### 3.6.7 Deactivating the Camera Reboot

By factory default, the MOBOTIX camera automatically reboots once a week between 3 a.m. and 4 a.m. The reason for this is that in some rare cases, external influences (for example, radiation at high altitudes) can sometimes lead to camera malfunctions. The automatic reboot will refresh the camera's memory and will ensure proper operation without requiring any interaction on the part of the user. If desired, you can deactivate the automatic reboot of the camera in the **Admin Menu > Time Tasks** dialog box.



### 3.6.8 Browser

Current Internet browsers (Internet Explorer, Mozilla Firefox, Safari, Google Chrome, Opera, etc.) with enabled JavaScript can display the camera's live images with their standard settings.

### 3.6.9 Cleaning the Camera and Lens

If the lens becomes dirty during the installation process, clean the lens using a lint-free cotton cloth. Make sure that the lens is still in focus after cleaning and adjust its focus if required.

#### Cleaning The Dome:

- Always mount and unmount the dome using the blue lens wrench (1.3) in order to protect it from being scratched and from getting dirty.
- You should clean the dome at regular intervals. Always use a soft, lint-free cotton cloth for this purpose.
- If the dirt is more persistent, add a mild alcohol-free detergent without abrasive particles.
- Make sure you instruct cleaning personnel on how to clean the camera.



### 3.6.10 Legal Notes

#### Legal aspects of video and sound recording

You must comply with all data protection regulations for video and sound monitoring when using MOBOTIX products. Depending on national laws and the installation location of the Q26, the recording of video and sound data may be subject to special documentation or it may be prohibited. All users of MOBOTIX products are therefore required to familiarize themselves with all valid regulations and comply with these laws. MOBOTIX AG is not liable for any illegal use of its products.



### 3.6.11 Safety Warnings

#### Installation Instructions:

- This product must not be used in locations exposed to the dangers of explosion.
- Make sure to install this product as shown in Chapter 2, «Installation» of this manual.
- When installing this product, make sure that you are only using genuine MOBOTIX parts and MOBOTIX connection cables.
- Make sure that you are installing this product on a solid surface that provides for a sturdy installation of the fixing elements used.



**Electrical installation:** Electrical systems and equipment may only be installed, modified and maintained by a qualified electrician or under the direction and supervision of a qualified electrician in accordance with the applicable electrical guidelines. Make sure to properly set up all electrical connections.





**Electrical surges:** MOBOTIX cameras are protected against the effects of small electrical surges by numerous measures. These measures, however, cannot prevent the camera from being damaged when stronger electrical surges occur. Special care should be taken when installing the camera outside of buildings to ensure proper protection against **lightning**, since this also protects the building and the whole network infrastructure.



**Max. power consumption of attached extension modules:** The power consumption of all attached **MxBus modules** must **not exceed 2.5 W**. When attaching modules to the MxBus connector **and** the USB socket, the **power consumption of all attached modules must not exceed 3 W, if the camera is powered by PoE class 3**. If **PoE class 2** is used, **the power consumption of all attached modules must not exceed 1 W!**



**Never touch the lens:** Due to the high performance of the Q26, the area of the image sensor **can get quite hot**, especially when the ambient temperature is also high. This does not affect the proper functioning of the camera in any way. For this reason, the product must not be installed within the reach of persons.





**Power off before opening the camera:** Make sure the power supply is disconnected before opening the camera (i.e., for installing or replacing sensor modules and SD cards).



**Network security:** MOBOTIX products include all of the necessary configuration options for operation in Ethernet networks in compliance with data protection laws. The operator is responsible for the data protection concept across the entire system. The basic settings required to prevent misuse can be configured in the software and are password-protected. This prevents unauthorized parties from accessing these settings.

### 3.6.12 Online Help in the Browser

For more information, see the News and Functional Overview pages in the online help of the camera's browser interface. Click on the  icon to open the camera's online help. Furthermore, detailed information on the camera and its current configuration is displayed in the **Camera Status** dialog box. Click on the  icon to open the relevant page.

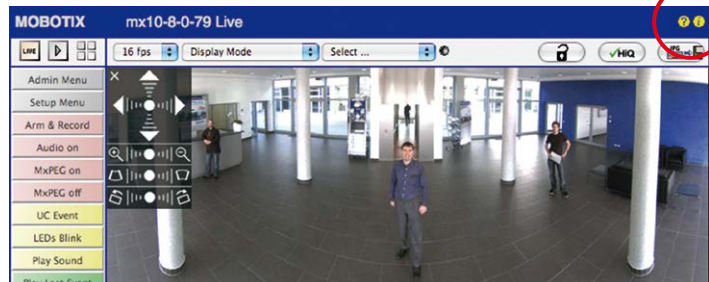

### 3.6.13 Declaration of Conformity

The products of MOBOTIX AG are certified according to the applicable directives of the E.U. and other countries. You can find the declarations of conformity of the products of MOBOTIX AG

under [www.mobotix.com](http://www.mobotix.com), **Support > Download Center > Documentation > Certificates & Declarations of Conformity**.

### 3.6.14 RoHS Declaration

The products of MOBOTIX AG are in full compliance with Art. 5 of the German Electrical and Electronic Equipment Act and the E.U. Directive 2011/65/EU on the Restriction of the Use of Certain Hazardous Substances in Electrical and Electronic Equipment (RoHS) as far as they are subject to these regulations. (You can find the MOBOTIX RoHS Declaration under [www.mobotix.com](http://www.mobotix.com), **Support > Download Center > Documentation > Brochures & Guides > Certificates**.)

### 3.6.15 Disposal

Electrical and electronic products contain many reusable materials. For this reason, we would ask that you dispose of MOBOTIX products at the end of their service life in accordance with all legal requirements and regulations (or deposit these products at a municipal collection center). MOBOTIX products may not be disposed of with household waste! If the product contains a battery, please dispose of the battery separately (the corresponding product manuals contain specific directions if the product contains a battery).



### 3.6.16 Disclaimer

Neither MOBOTIX AG nor any subsidiary of MOBOTIX AG will assume any responsibility for damage resulting from improper use of its products or failure to comply with the manuals and the applicable rules and regulations. Our **General Terms and Conditions** apply. You can download the current version of the General Terms and Conditions from our website at [www.mobotix.com](http://www.mobotix.com) by clicking on the **COS** link at the bottom of every page.





# MOBOTIX

BeyondHumanVision

## Manufacturer

MOBOTIX AG  
Kaiserstrasse  
67722 Langmeil  
Germany

Phone: +49 6302 9816-103

Fax: +49 6302 9816-190

[www.mobotix.com](http://www.mobotix.com)

[sales@mobotix.com](mailto:sales@mobotix.com)

Registration Office: Kaiserslautern Local Court

Registration Number: HRB 3724

Tax Office: Worms-Kirchheimbolanden, Germany

Tax Code: 44/676/0700/4

VAT ID: DE202203501

You can find the latest version of this and other documents (e.g., declarations of conformity) at [www.mobotix.com](http://www.mobotix.com) in the **Support > Download Center > Documentation > Manuals** section.



Technical specifications subject to change without notice!

Camera Manual

# Q26 Hemispheric

